

la luce del legno
the light of wood

MOOD
WOOD

PORTE LACCATE PER INTERNI

Porte protagoniste dell'interior design. Studiata armonia di accostamenti cromatici e stilistici, per le porte laccate Dierre: presenze luminose che esprimono le tendenze più attuali del design e dell'arredamento.

LACQUERED INTERNAL DOORS

Doors as stars of interior design. A well defined blend of colour and stylistic matches, for the Dierre lacquered doors: bright items expressing the latest trends in both design and furnishing.

MOOD
WOOD
L U C E
L I G H T
L E G N O
W O O D

BONAPARTE	8 - 19
JUVARRA	20 - 51
LUCCHINI	52 - 63
BELLINI	64 - 113
DANIELI	114 - 163
SAVINI - LACCATE	164 - 179
<i>SAVINI - LACQUERED</i>	
FORTE	180 - 207
SCHEDE TECNICHE	212 - 237
<i>TECHNICAL SHEETS</i>	



FORTE F

Versione cieca
Colore laccata
RAL 7036
Coprifilo M20 a 45°

Version blank
Colour lacquered
RAL 7036
**Cover
mould** M20 at 45°

Un'immensa varietà di tinte e sfumature inedite per un caleidoscopio di linee e disegni. La luce si traduce in colore, ed esalta il pregio dell'essenze utilizzate. L'energia e una forte identità sono il segno distintivo di una collezione ispirata alla diversità, alla molteplicità come unicità.

I L L U M I N A
B R I G H T E N S

A huge variety of brand-new colours and shades for a kaleidoscope of lines and patterns. The light is reflected through colour while enhancing the precious wood types used. The distinctive sign of a collection inspired to diversity, to variety as uniqueness stands out through energy and a strong identity.

Le porte laccate Dierre raccontano di voi, del vostro gusto, della vostra fantasia. Infinite le possibilità di personalizzazione all'interno delle variegatissime proposte stilistiche. Dalle linee d'ispirazione "neo-classica" ai progetti ultracontemporanei, in tutti classe ed eleganza restano inconfondibili.

C O N S T I L E
W I T H S T Y L E

Dierre lacquered doors tell about you, your taste, your imagination. Endless personalization possibilities within the many diversified style proposals. From the neo-classical inspired lines to extremely contemporary projects, all with an unmistakable class and elegance.

F O R T E

Disegni e profili moderni e originali, per le porte laccate Forte. Un'eleganza di gusto decisamente attuale, progettata per vivere in sintonia con le esigenze, le abitudini e lo stile delle famiglie contemporanee.

F O R T E

For the Forte lacquered doors, modern and unusual designs and profiles. A very up-to-date elegance, designed to live in harmony with the requirements, the habits and the style of contemporary families.

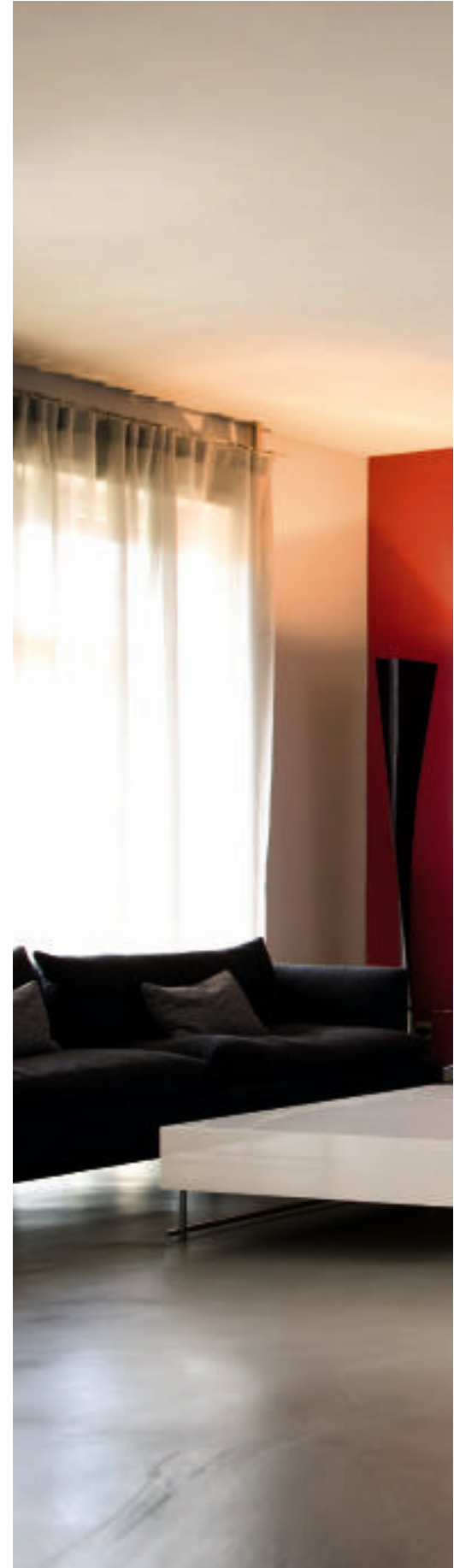



FORTE 4

Versione cieca
Colore laccata
RAL 3031
Coprifilo M20 a 45°

Version blank
Colour lacquered
RAL 3031
**Cover
mould** M20 at 45°



FORTE 1

Versione cieca
Colore laccata
RAL 1034
Coprifilo M20 a 45°

Version blank
Colour lacquered
RAL 1034
**Cover
mould** M20 at 45°

FORTE 2

Versione	<i>cieca</i>
Colore	<i>laccata avorio</i>
Coprifilo	<i>M20 a 45°</i>
Version	<i>blank</i>
Colour	<i>lacquered ivory</i>
Cover mould	<i>M20 at 45°</i>



FORTE 3

Versione	<i>cieca</i>
Colore	<i>laccata RAL 7044</i>
Coprifilo	<i>M20 a 45°</i>
Version	<i>blank</i>
Colour	<i>lacquered RAL 7044</i>
Cover mould	<i>M20 at 45°</i>



FORTE 5

Versione cieca
Colore laccata
RAL 6003
Coprifilo M20 a 45°

Version blank
Colour lacquered
RAL 6003
**Cover
mould** M20 at 45°

FORTE 6

Versione cieca

Colore laccata
RAL 7035

Coprifilo M20 a 45°

Version blank

Colour lacquered
RAL 7035

**Cover
mould** M20 at 45°



FORTE 7

Versione cieca

Colore laccata
RAL 1001

Coprifilo M20 a 45°

Version blank

Colour lacquered
RAL 1001

**Cover
mould** M20 at 45°





FORTE 8

Versione	<i>cieca</i>
Colore	<i>laccata RAL 6021</i>
Coprifilo	<i>M20 a 45°</i>
Version	<i>blank</i>
Colour	<i>lacquered RAL 6021</i>
Cover mould	<i>M20 at 45°</i>

FORTE 9

Versione cieca
con riquadro
centrale e profili
in ottone lucido

Colore laccata
RAL 7030

Coprifilo M20 a 45°

Version blank with
central section
and polished
brass profiles

Colour lacquered
RAL 7030

**Cover
mould** M20 at 45°

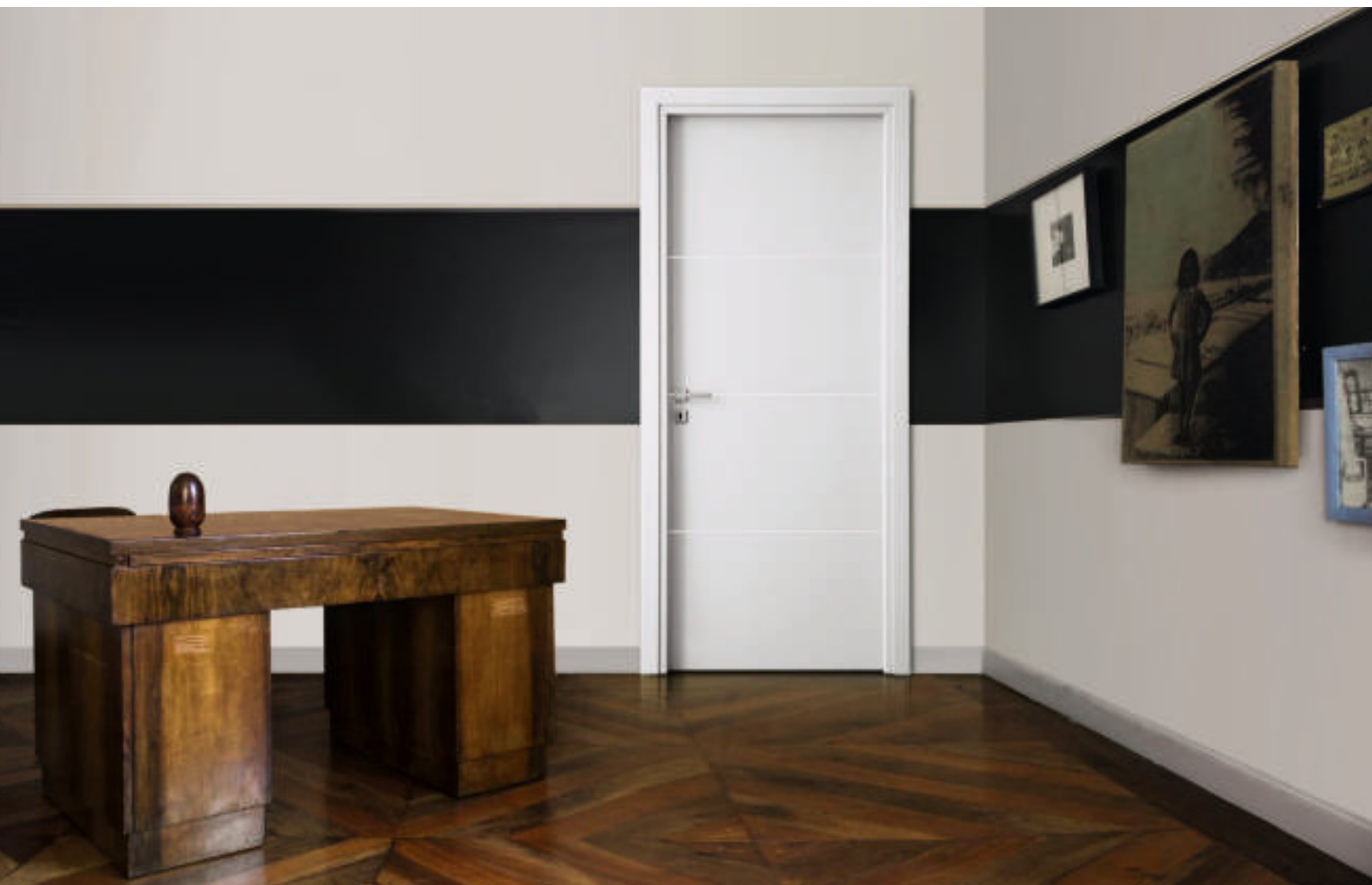

FORTE 9

Versione cieca
con 4 riquadri
e profili in inox

Colore laccata
bianco neve

Coprifilo M20 a 45°

Version blank with
4 sections
and stainless
steel profiles

Colour lacquered
snow white

**Cover
mould** M20 at 45°



FORTE A

Versione cieca
Colore laccata
RAL 7001
Coprifilo M20 a 45°

Version blank
Colour lacquered
RAL 7001
**Cover
mould** M20 at 45°

FORTE B

Versione	cieca
Colore	laccata RAL
Coprifilo	M20 a 45°
Version	<i>blank</i>
Colour	<i>lacquered</i> RAL 7044
Cover mould	<i>M20 at 45°</i>







FORTE C

Versione *cieca*

Colore *laccata*
 RAL 7037

Coprifilo *M20 a 45°*

Version *blank*

Colour *lacquered*
 RAL 7037

Cover
mould *M20 at 45°*



FORTE D

Versione cieca
Colore laccata
RAL 1001
Coprifilo M20 a 45°

Version blank
Colour lacquered
RAL 1001
**Cover
mould** M20 at 45°



FORTE E

Versione cieca
Colore laccata
RAL 1015
Coprifilo M20 a 45°

Version blank
Colour lacquered
RAL 1015
**Cover
mould** M20 at 45°



FORTE L

Versione cieca
Colore laccata
RAL 7040
Coprifilo M20 a 45°

Version blank
Colour lacquered
RAL 7040
**Cover
mould** M20 at 45°



FORTE F

Versione cieca
Colore laccata
RAL 7036
Coprifilo M20 a 45°

Version blank
Colour lacquered
RAL 7036
**Cover
mould** M20 at 45°



FORTE H

Versione cieca
Colore laccata
RAL 7031
Coprifilo M20 a 45°

Version blank
Colour lacquered
RAL 7031
**Cover
mould** M20 at 45°





FORTE G

Versione	<i>cieca</i>
Colore	<i>laccata RAL 7035</i>
Coprifilo	<i>M20 a 45°</i>
Version	<i>blank</i>
Colour	<i>lacquered RAL 7035</i>
Cover mould	<i>M20 at 45°</i>

FORTE I

Versione	<i>cieca</i>
Colore	<i>laccata RAL 7035</i>
Coprifilo	<i>M20 a 45°</i>
Version	<i>blank</i>
Colour	<i>lacquered RAL 7035</i>
Cover mould	<i>M20 at 45°</i>







FORTE N

Versione cieca

Colore laccata
RAL 1001

Coprifilo M20 a 45°

Version blank

Colour lacquered
RAL 1001

**Cover
mould** M20 at 45°

FORTE M

Versione	<i>cieca</i>
Colore	<i>laccata RAL 1019</i>
Coprifilo	<i>M20 a 45°</i>
Version	<i>blank</i>
Colour	<i>lacquered RAL 1019</i>
Cover mould	<i>M20 at 45°</i>



FORTE O

Versione	<i>finestrata</i>
Colore	<i>laccata RAL 7046</i>
Coprifilo	<i>M20 a 45°</i>
Version	<i>glazed</i>
Colour	<i>lacquered RAL 7046</i>
Cover mould	<i>M20 at 45°</i>





FORTE P

Versione	<i>cieca</i>
Colore	<i>laccata bianco neve</i>
Coprifilo	<i>M20 a 45°</i>
Version	<i>blank</i>
Colour	<i>lacquered snow white</i>
Cover mould	<i>M20 at 45°</i>

ALLESTIMENTI | TYPES

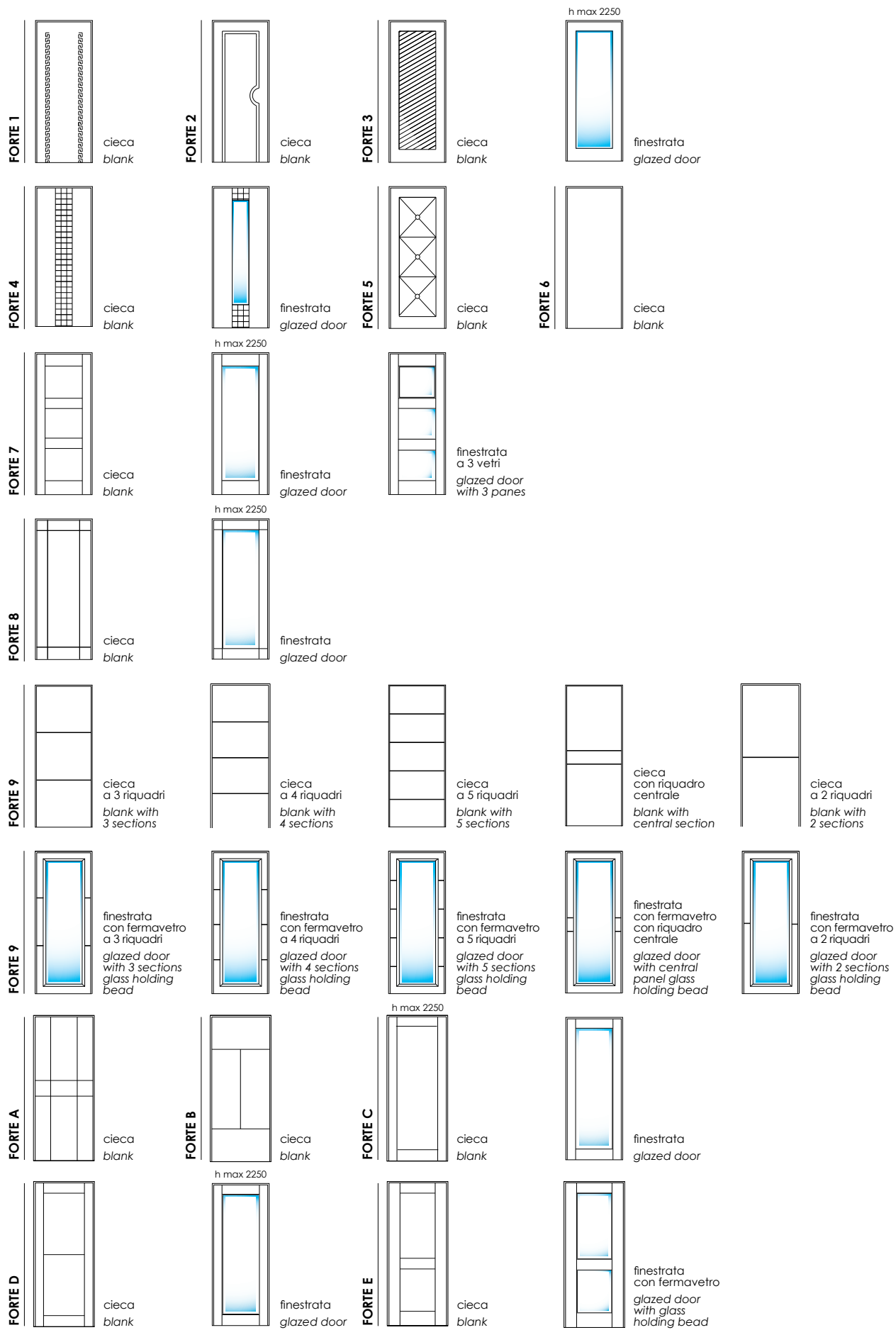

CONFIGURAZIONI FORTE FORTE CONFIGURATIONS

ALLESTIMENTI | TYPES

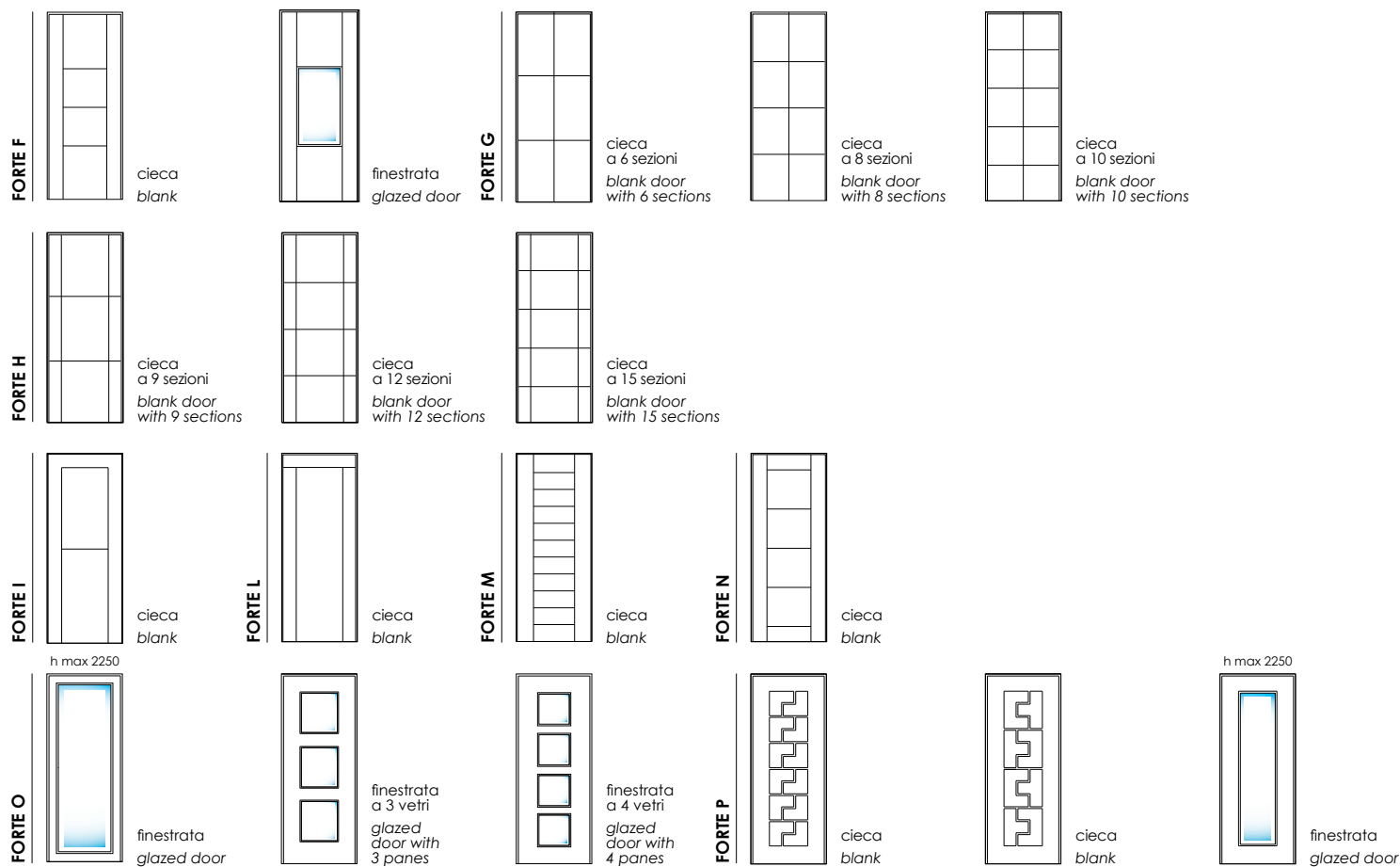

SOLUZIONI DI APERTURA | OPENING FEATURES

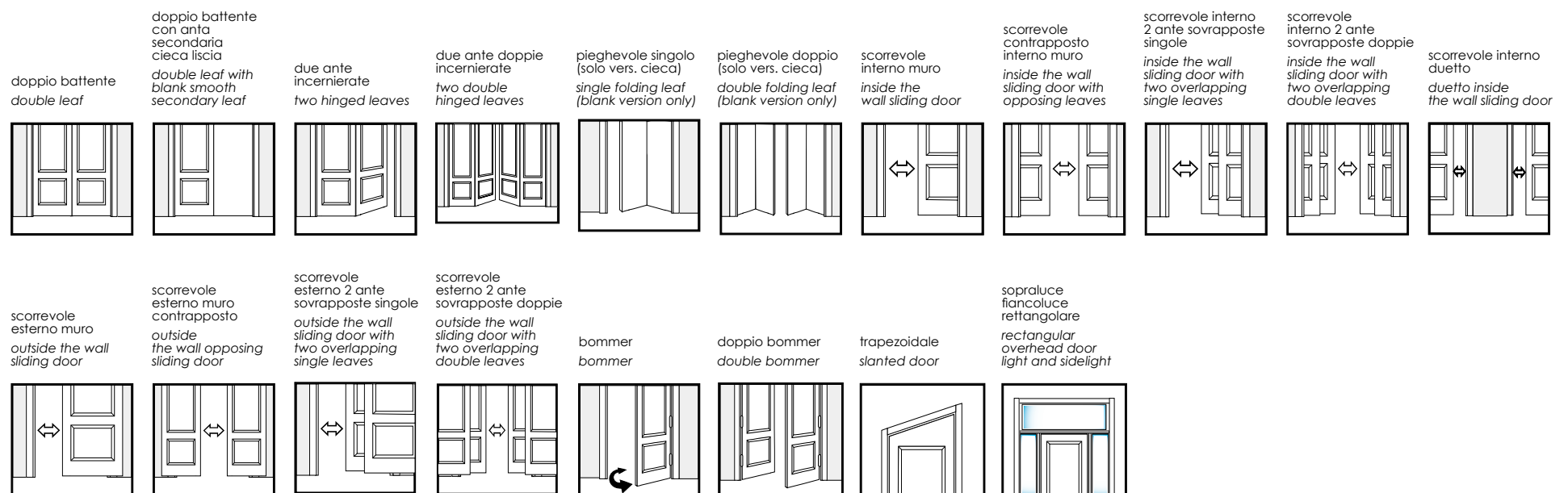

LACCATURE DISPONIBILI | AVAILABLE LACQUERINGS

Ogni modello della famiglia Forte è disponibile nelle versioni laccato avorio, laccato bianco, laccato RAL, laccato RAL scuro e grezzo.
Each model of the Forte family is available in the lacquered ivory, lacquered white, lacquered in RAL, lacquered in RAL dark and crude.

Tutte le configurazioni e le soluzioni di apertura possono essere adattate su misura.
Scopri le innumerevoli possibilità di personalizzazione presso i Dierre Partner.
All opening configurations and solutions may be tailored. Discover the endless personalization possibilities at the Dierre Partners

Una porta Dierre è Dierre in tutti i dettagli. Ogni particolare rivela l'incontro esclusivo tra artigianalità e tecnologie avanzate; tra ricerca estrosa e progettazione rigorosa; tra sperimentazione e attenzione ai materiali utilizzati. A cominciare dalla verniciatura, realizzata nel pieno rispetto della natura, con prodotti che coniugano esigenze estetiche, performance e salvaguardia dell'ambiente. Ma una porta Dierre sa anche essere come volete voi. Oltre alle linee e ai colori, tantissime le soluzioni di apertura e configurazione, dalle versioni più semplici e lineari a quelle più complesse.

S U I D E T T A G L I
L U C E
H I G H L I G H T E D D E T A I L S

A Dierre door is Dierre in every single detail. Each item reveals the exclusive blend between craftsmanship and advanced technology; between fanciful research and true design; between experimentation and attention to the materials used. Starting from varnishing, carried out paying attention to nature, with products that combine aesthetic requirements, performance and safeguard of the environment. But a Dierre door also knows how to be exactly as you like it. In addition to lines and colours, many opening and configuration solutions, from the simpler and linear one to the more complex versions.

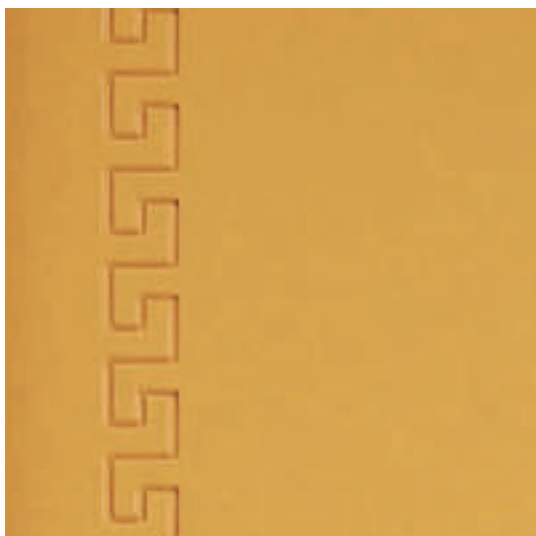

S C H E D E T E C N I C H E
T E C H N I C A L S H E E T S

BELLINI - BONAPARTE - DANIELI - FORTE - JUVARRA - LUCCHINI
 APERTURA AD UN'ANTA
 SINGLE LEAF OPENING

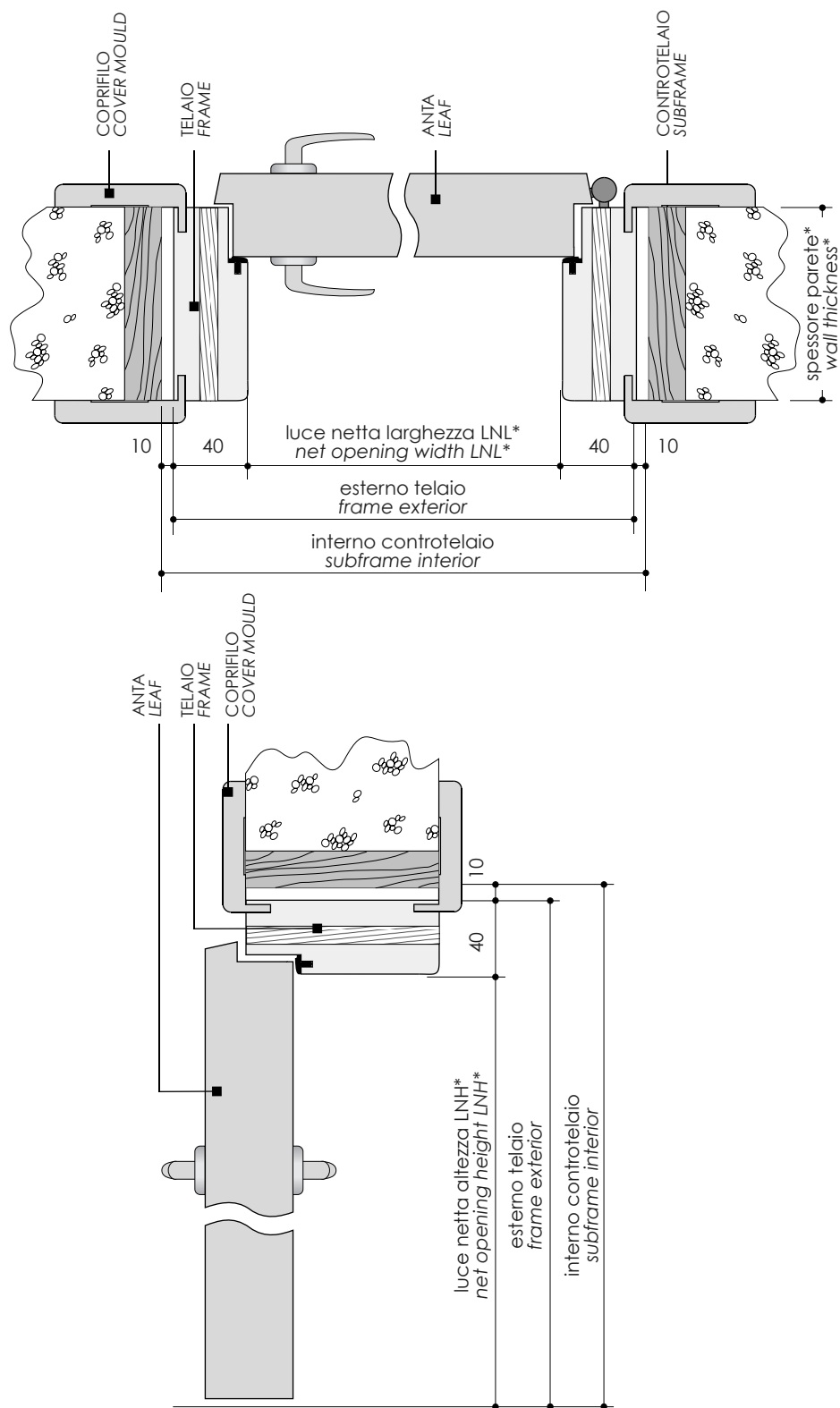
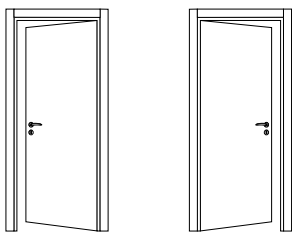

TUTTI I RIFERIMENTI CON L'ASTERISCO (*) SONO DA INDICARE NELL'ORDINE
 PER LA CONFIGURAZIONE STANDARD CORRETTA TELAIO / COPRIFILO DI OGNI FAMIGLIA CONSULTARE IL LISTINO
 ALL REFERENCES BEARING THE ASTERISCS (*) MUST BE INDICATED IN THE ORDER
 CONSULT THE PRICELIST FOR THE CORRECT STANDARD CONFIGURATION OF FRAME / COVER MOULD OF EACH FAMILY

SVILUPPO MISURE ALTEZZA MEASUREMENTS DEVELOPMENT HEIGHT			SVILUPPO MISURE LARGHEZZA MEASUREMENTS DEVELOPMENT WIDTH		
INTERNO CONTROTELAIO SUBFRAME INTERIOR	ESTERNO TELAIO FRAME EXTERIOR	LUCE NETTA ALTEZZA NET OPENING HEIGHT	INTERNO CONTROTELAIO SUBFRAME INTERIOR	ESTERNO TELAIO FRAME EXTERIOR	LUCE NETTA LARGHEZZA NET OPENING WIDTH
LNH + 50	LNH + 40	LNH	LNL + 100	LNL + 80	LNL
2150	2140	2100	900	880	800

TUTTI I RIFERIMENTI CON L'ASTERISCO (*) SONO DA INDICARE NELL'ORDINE PER LA CONFIGURAZIONE STANDARD CORRETTA TELAIO / COPRIFILO DI OGNI FAMIGLIA CONSULTARE IL LISTINO ALL REFERENCES BEARING THE ASTERISCS (*) MUST BE INDICATED IN THE ORDER CONSULT THE PRICELIST FOR THE CORRECT STANDARD CONFIGURATION OF FRAME / COVER MOULD OF EACH FAMILY

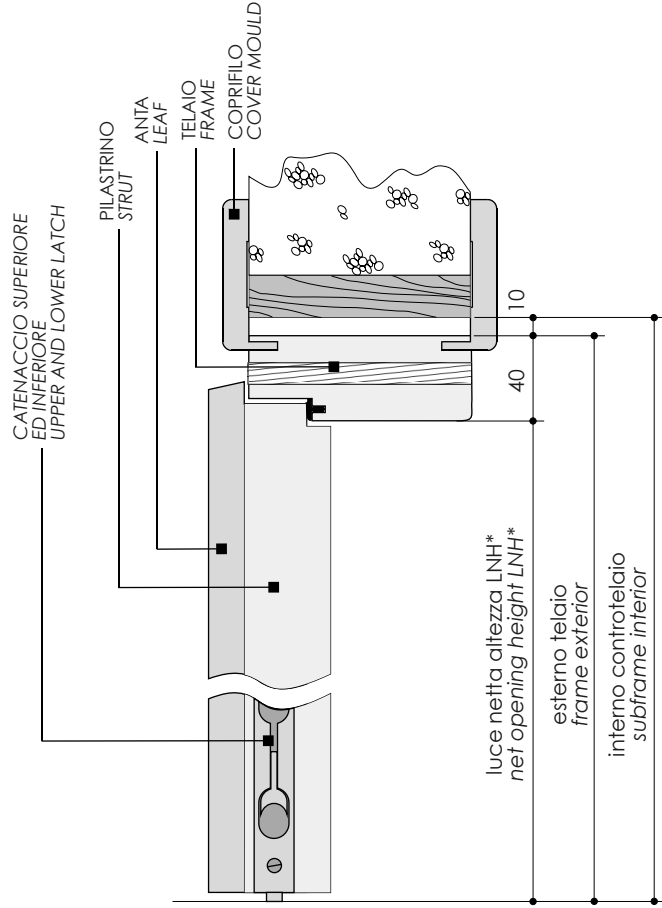
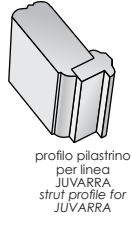
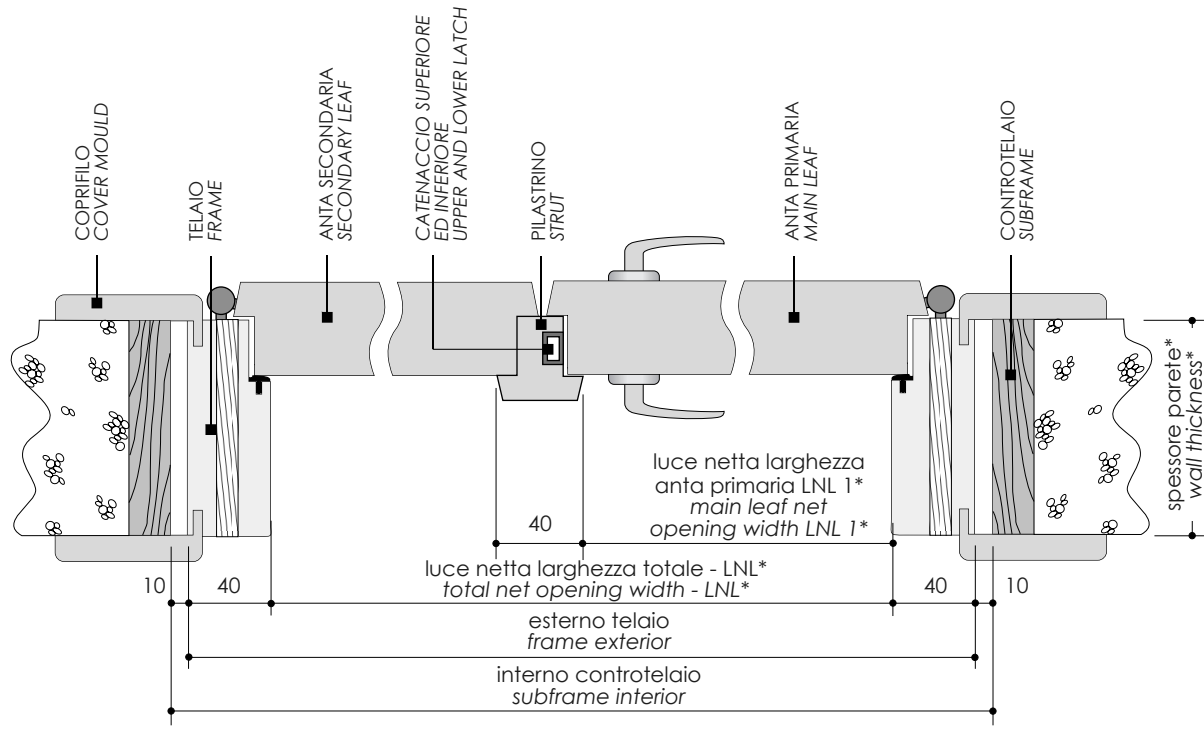

SVILUPPO MISURE ALTEZZA MEASUREMENTS DEVELOPMENT HEIGHT		
INTERNO CONTROTELAIO SUBFRAME INTERIOR	ESTERNO TELAIO FRAME EXTERIOR	LUCE NETTA ALTEZZA NET OPENING HEIGHT
LNH + 50	LNH + 40	LNH
2150	2140	2100

SVILUPPO MISURE LARGHEZZA MEASUREMENTS DEVELOPMENT WIDTH			
INTERNO CONTROTELAIO SUBFRAME INTERIOR	ESTERNO TELAIO FRAME EXTERIOR	LUCE NETTA LARGHEZZA NET OPENING WIDTH	LUCE LARGHEZZA ANTA PRIMARIA MAIN LEAF OPENING WIDTH
LNL + 100	LNL + 80	LNL	LNL 1
1540	1520	1420	800

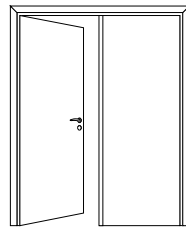
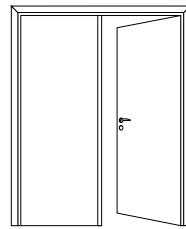

DOUBLE LEAF OPENING
APERTURA A DUE ANTE
BELLINI - BONAPARTE - DANIELI - FORTE - JUVARRA - LUCCHINI

BELLINI - DANIELI - FORTE - JUVARRA - LUCCHINI - SAVINI
 APERTURA A DUE ANTE INCERNIERATE
 DOUBLE HINGED LEAF OPENING

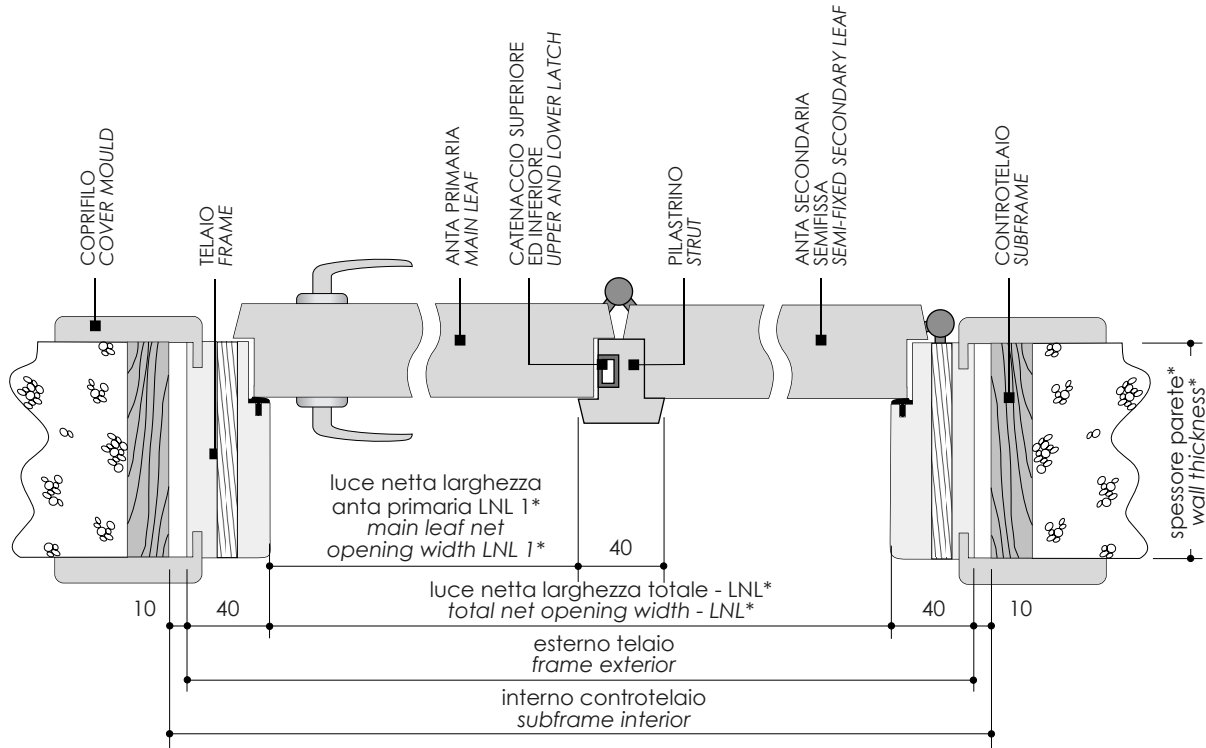
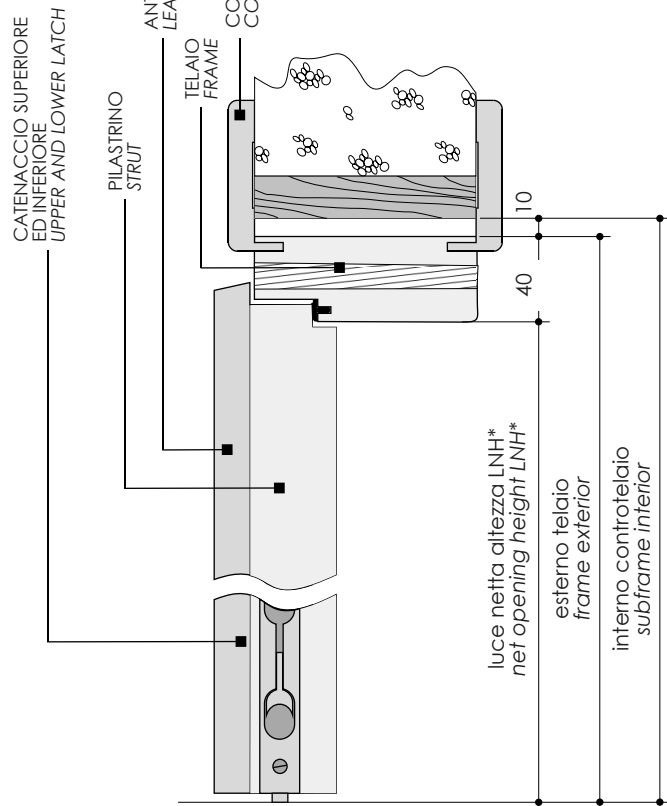
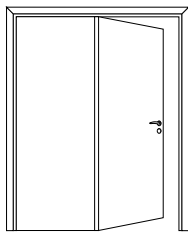
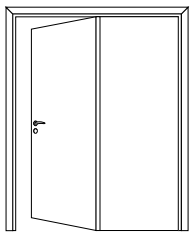

SVILUPPO MISURE ALTEZZA MEASUREMENTS DEVELOPMENT HEIGHT			SVILUPPO MISURE LARGHEZZA MEASUREMENTS DEVELOPMENT WIDTH			
INTERNO CONTROTELAIO SUBFRAME INTERIOR	ESTERNO TELAIO FRAME EXTERIOR	LUCE NETTA ALTEZZA NET OPENING HEIGHT	INTERNO CONTROTELAIO SUBFRAME INTERIOR	ESTERNO TELAIO FRAME EXTERIOR	LUCE NETTA LARGHEZZA NET OPENING WIDTH	LUCE LARGHEZZA ANTA PRIMARIA MAIN LEAF OPENING WIDTH
LNH + 50	LNH + 40	LNH	LNL + 100	LNL + 80	LNL	LNL 1
2150	2140	2100	1540	1520	1420	800

TUTTI I RIFERIMENTI CON L'ASTERISCO (*) SONO DA INDICARE NELL'ORDINE PER LA CONFIGURAZIONE STANDARD CORRETTA TELAIO / COPRIFILO DI OGNI FAMIGLIA. CONSULTARE IL LISTINO ALL'REFERENZE BEARING THE ASTERISCS (*) MUST BE INDICATED IN THE ORDER CONSULT THE PRICELIST FOR THE CORRECT STANDARD CONFIGURATION OF FRAME / COVER MOULD OF EACH FAMILY

TUTTI I RIFERIMENTI CON L'ASTERISCO (*) SONO DA INDICARE NELL'ORDINE PER LA CONFIGURAZIONE STANDARD CORRETTA TELAI0 / COPRIFILO DI OGNI FAMIGLIA CONSULTARE IL LISTINO ALL REFERENCES BEARING THE ASTERISCS (*) MUST BE INDICATED IN THE ORDER CONSULT THE PRICELIST FOR THE CORRECT STANDARD CONFIGURATION OF FRAME / COVER MOULD OF EACH FAMILY

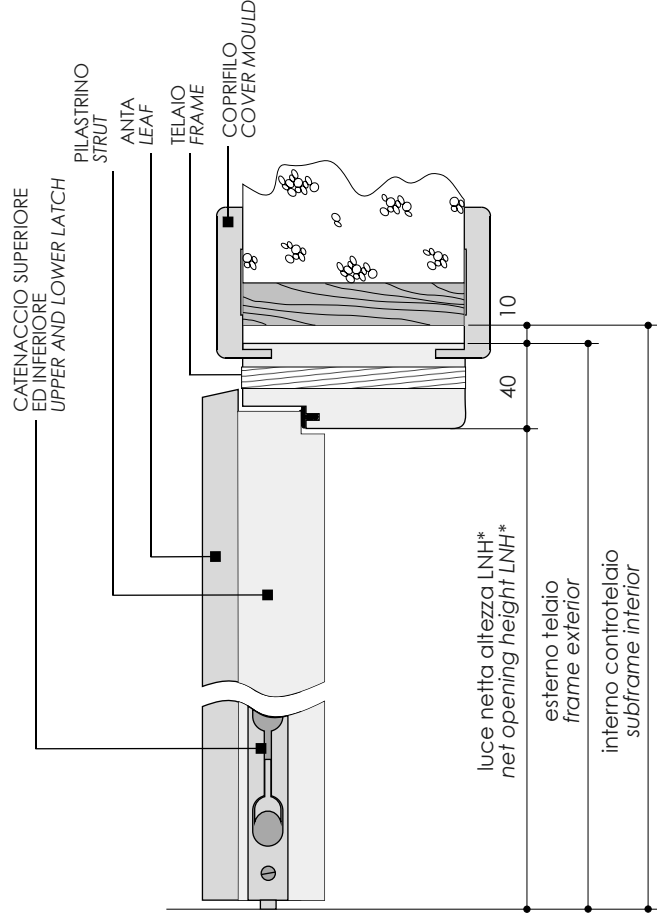
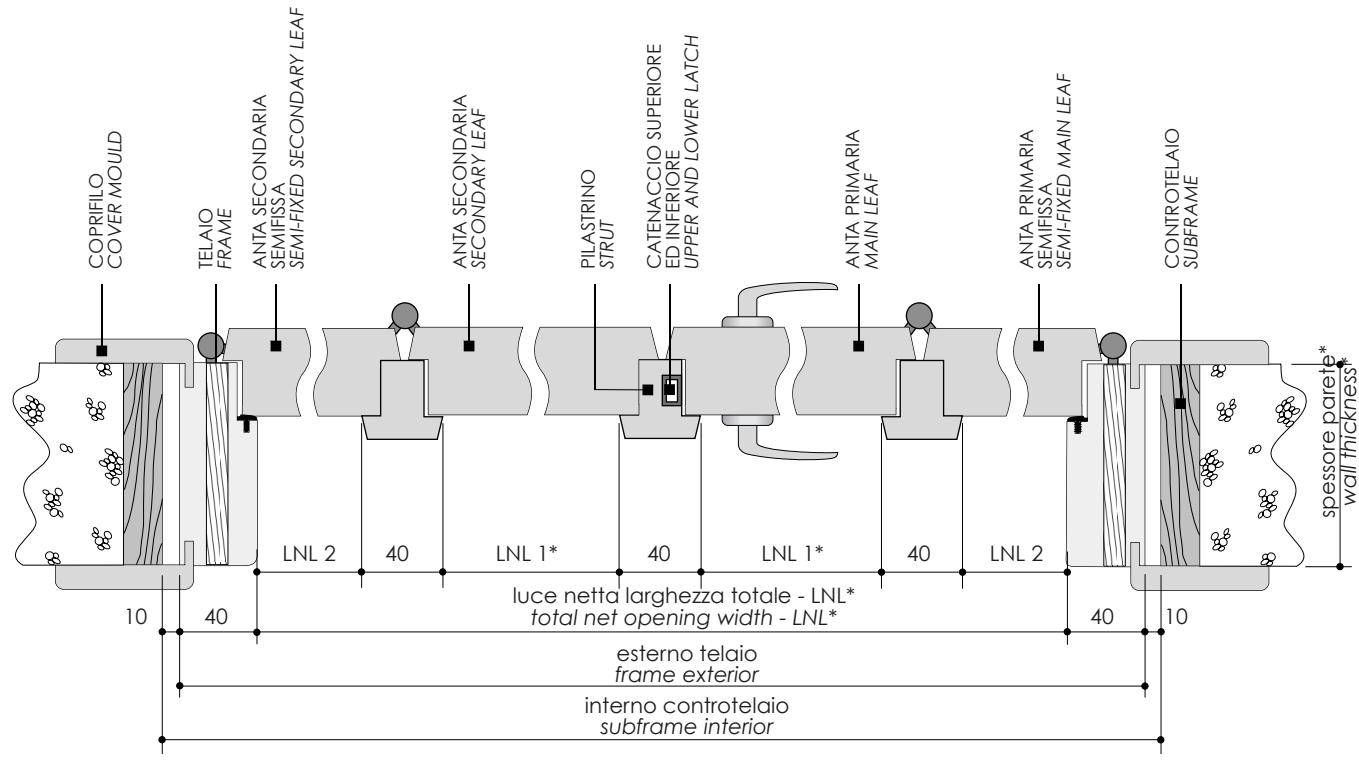

SVILUPPO MISURE LARGHEZZA MEASUREMENTS DEVELOPMENT HEIGHT		
INTERNO CONTROTELAIO SUBFRAME INTERIOR	ESTERNO TELAIO FRAME EXTERIOR	LUCE NETTA ALTEZZA NET OPENING HEIGHT
LNH + 50	LNH + 40	LNH
2150	2140	2100

SVILUPPO MISURE LARGHEZZA MEASUREMENTS DEVELOPMENT WIDTH			
INTERNO CONTROTELAIO SUBFRAME INTERIOR	ESTERNO TELAIO FRAME EXTERIOR	LUCE NETTA LARGHEZZA NET OPENING WIDTH	LUCE LARGHEZZA ANTA PRIMARIA MAIN LEAF OPENING WIDTH
LNL + 100	LNL + 80	LNL	LNL 1
2900	2880	2800	700

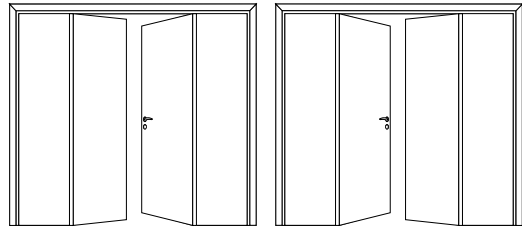

DOUBLE HINGED DOUBLE LEAF OPENING
APERTURA A DUE ANTE INCERNIERATE DOPPIE
BELLINI - DANIELI - FORTE - JUVARRA - LUCCHINI

SAVINI
APERTURA AD UN'ANTA
 SINGLE LEAF OPENING

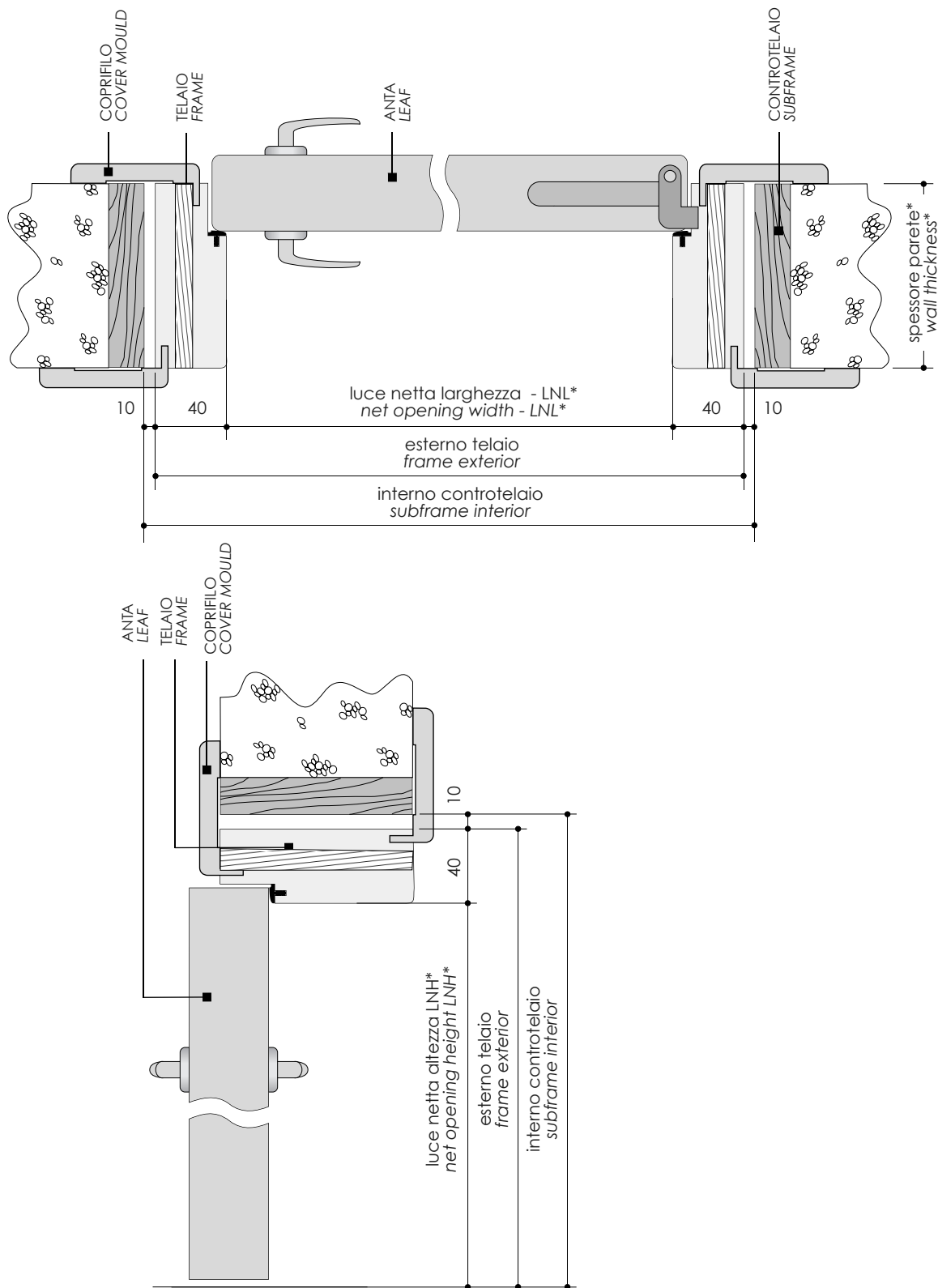
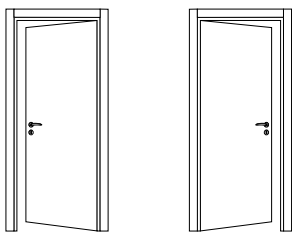

TUTTI I RIFERIMENTI CON L'ASTERISCO (*) SONO DA INDICARE NELL'ORDINE PER LA CONFIGURAZIONE STANDARD CORRETTA TELAIO / COPRIFILO DI OGNI FAMIGLIA. CONSULTARE IL LISTINO ALL'INDIRIZZO BEARING THE ASTERISCS (*) MUST BE INDICATED IN THE ORDER CONSULT THE PRICELIST FOR THE CORRECT STANDARD CONFIGURATION OF FRAME / COVER MOULD OF EACH FAMILY

SVILUPPO MISURE ALTEZZA MEASUREMENTS DEVELOPMENT HEIGHT			SVILUPPO MISURE LARGHEZZA MEASUREMENTS DEVELOPMENT WIDTH		
INTERNO CONTROTELAIO SUBFRAME INTERIOR	ESTERNO TELAIO FRAME EXTERIOR	LUCE NETTA ALTEZZA NET OPENING HEIGHT	INTERNO CONTROTELAIO SUBFRAME INTERIOR	ESTERNO TELAIO FRAME EXTERIOR	LUCE NETTA LARGHEZZA NET OPENING WIDTH
LNH + 50	LNH + 40	LNH	LNL + 100	LNL + 80	LNL
2150	2140	2100	900	880	800

TUTTI I RIFERIMENTI CON L'ASTERISCO (*) SONO DA INDICARE NELL'ORDINE PER LA CONFIGURAZIONE STANDARD CORRETTA TELAIO / COPRIFILO DI OGNI FAMIGLIA CONSULTARE IL LISTINO ALL REFERENCES BEARING THE ASTERISCS (*) MUST BE INDICATED IN THE ORDER CONSULT THE PRICELIST FOR THE CORRECT STANDARD CONFIGURATION OF FRAME / COVER MOULD OF EACH FAMILY

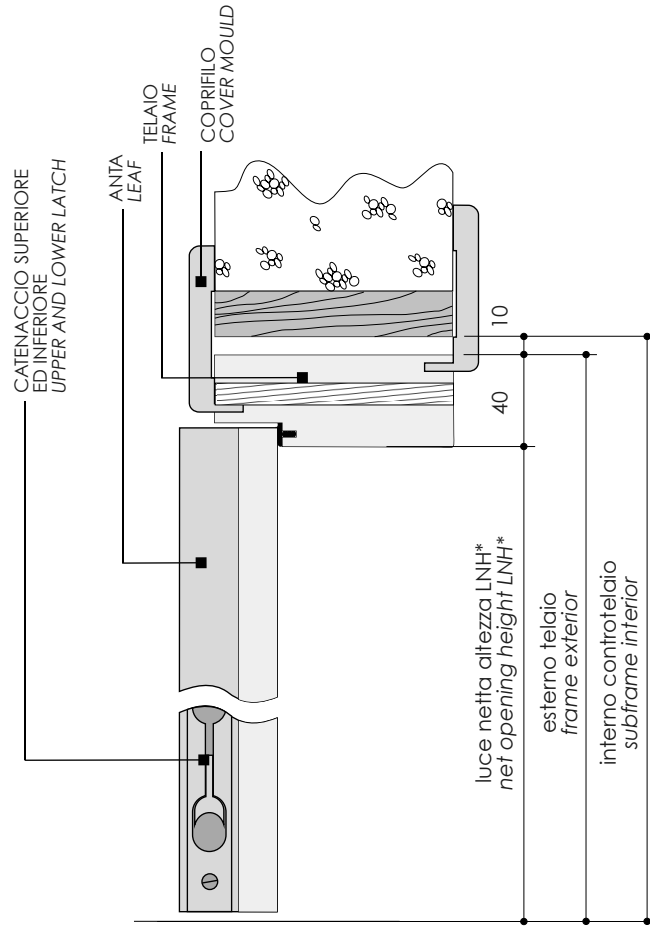
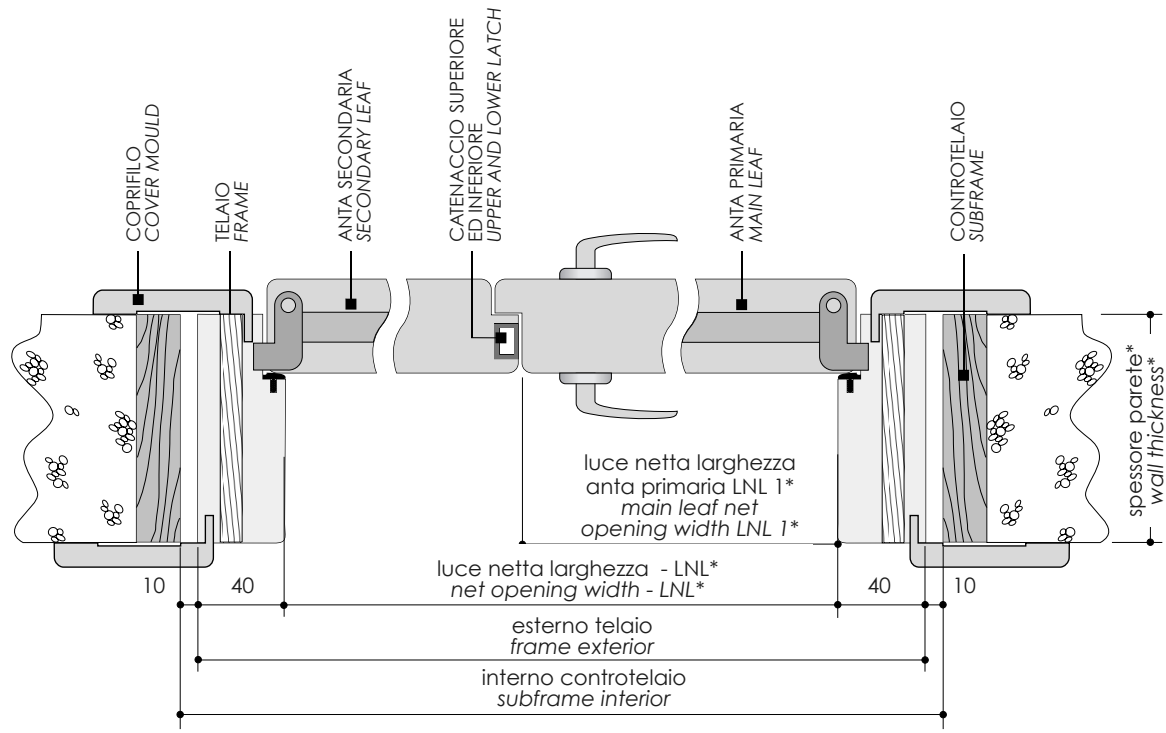

SVILUPPO MISURE ALTEZZA MEASUREMENTS DEVELOPMENT HEIGHT		
INTERNO CONTROTELAIO SUBFRAME INTERIOR	ESTERNO TELAIO FRAME EXTERIOR	LUCE NETTA ALTEZZA NET OPENING HEIGHT
LNH + 50	LNH + 40	LNH
2150	2140	2100

SVILUPPO MISURE LARGHEZZA MEASUREMENTS DEVELOPMENT WIDTH			
INTERNO CONTROTELAIO SUBFRAME INTERIOR	ESTERNO TELAIO FRAME EXTERIOR	LUCE NETTA LARGHEZZA NET OPENING WIDTH	LUCE LARGHEZZA ANTA PRIMARIA MAIN LEAF OPENING WIDTH
LNL + 100	LNL + 80	LNL	LNL 1
1540	1520	1420	800

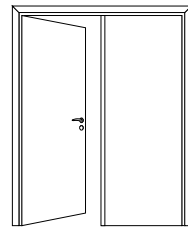
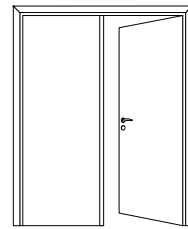

DOUBLE LEAF OPENING
 APERTURA A DUE ANTE
 SAVINI

BELLINI - DANIELI - FORTE - JUVARRA - LUCCHINI - SAVINI
APERTURA SCORREVOLE INTERNO MURO AD UN'ANTA
 SINGLE LEAF INSIDE THE WALL SLIDING OPENING

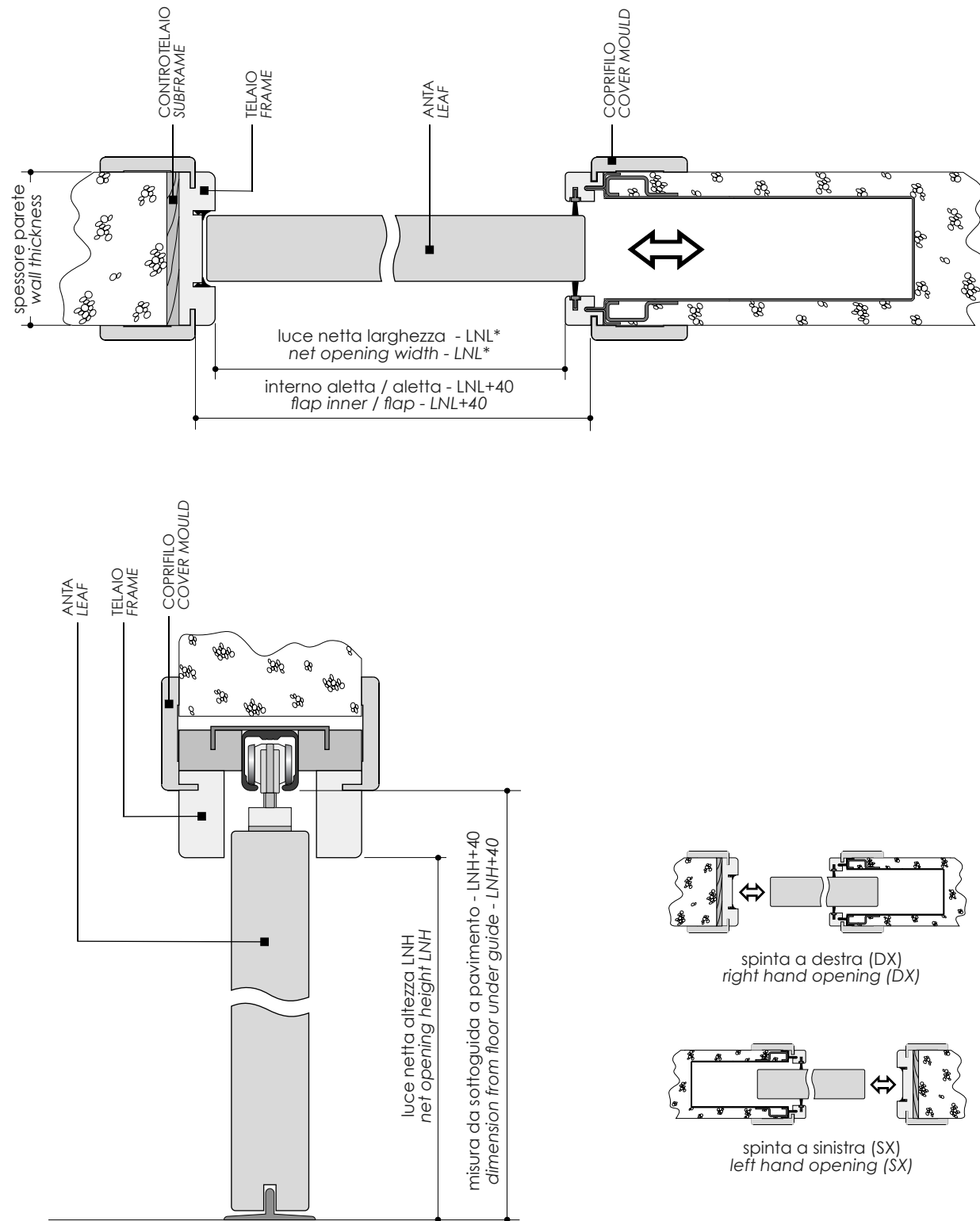
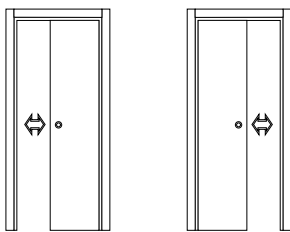

SVILUPPO MISURE ALTEZZA MEASUREMENTS DEVELOPMENT HEIGHT		SVILUPPO MISURE LARGHEZZA MEASUREMENTS DEVELOPMENT WIDTH			DIMENSIONE ANTA LEAF DIMENSION	
MISURA DA SOTTOGUIDA DIMENSION FROM UNDER GUIDE	LUCE NETTA ALTEZZA NET OPENING HEIGHT	LUCE INTERNO ALETTA/ALETTA FLAP INNER DIMENSION / FLAP	LUCE LARGHEZZA NOMINALE NOMINAL OPENING WIDTH	LUCE LARGHEZZA REALE REAL OPENING WIDTH	ALTEZZA ANTA LEAF HEIGHT	LARGHEZZA ANTA LEAF WIDTH
LNH + 40	LNH	LNL + 40	LNL *	LNL - 10	LNH+5	LNL +15
2140	2100	840	800	790	2105	815

TUTTI I RIFERIMENTI CON L'ASTERISCO (*) SONO DA INDICARE NELL'ORDINE L'INDICAZIONE DELLA SPINTA E NECESSARIA ESCLUSIVAMENTE PER LE PORTE VETRATE. AL FINE DI SEGNALARNE LA PARTE A VISTA DEL VETRO PER LA CONFIGURAZIONE STANDARD CORRETTA TELAIIO / COPRIFILO DI OGNI FAMIGLIA CONSULTARE IL LISTINO
 ALL REFERENCES BEARING THE ASTERISCS (*) MUST BE INDICATED IN THE ORDER THE OPENING HAND INDICATION IS NECESSARY SOLELY FOR GLAZED DOORS SO AS TO INDICATE THE GLASS PRESENCE CONSULT THE PRICELIST FOR THE CORRECT STANDARD CONFIGURATION OF FRAME / COVER MOULD OF EACH FAMILY

TUTTI I RIFERIMENTI CON L'ASTERISCO (*) SONO DA INDICARE NELL'ORDINE PER LA CONFIGURAZIONE STANDARD CORRETTA. TELAIIO / COPRIFILO DI OGNI FAMIGLIA. CONSULTARE IL LISTINO ALL REFERENCES BEARING THE ASTERISCS (*) MUST BE INDICATED IN THE ORDER CONSULT THE PRICELIST FOR THE CORRECT STANDARD CONFIGURATION OF FRAME / COVER MOULD OF EACH FAMILY

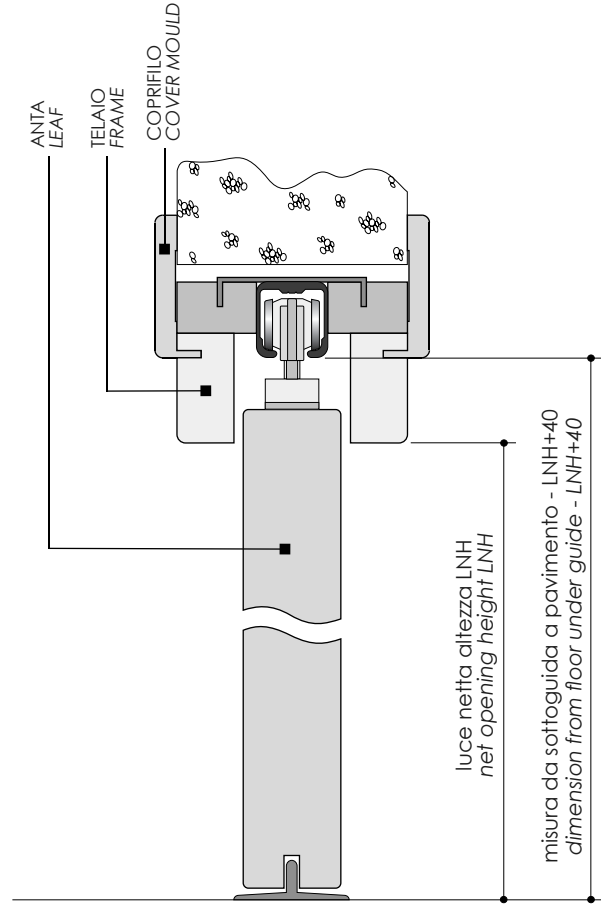
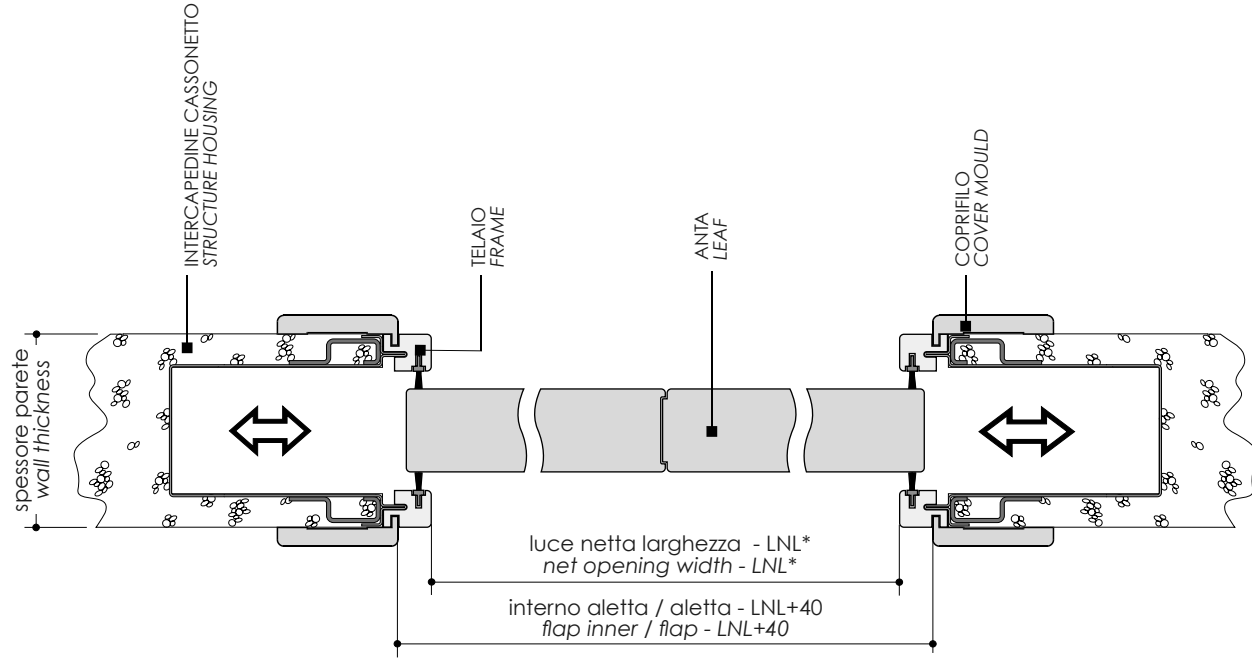

SVILUPPO MISURE ALTEZZA MEASUREMENTS DEVELOPMENT HEIGHT		SVILUPPO MISURE LARGHEZZA MEASUREMENTS DEVELOPMENT WIDTH			DIMENSIONE ANTA LEAF DIMENSION	
MISURA DA SOTTOGUIDA DIMENSION FROM UNDER GUIDE	LUCE NETTA ALTEZZA NET OPENING HEIGHT	LUCE INTERNO ALETTA/ALETTA FLAP INNER DIMENSION / FLAP	LUCE LARGHEZZA NOMINALE NOMINAL OPENING WIDTH	LUCE LARGHEZZA REALE REAL OPENING WIDTH	ALTEZZA ANTA LEAF HEIGHT	LARGHEZZA ANTA LEAF WIDTH
LNH + 40	LNH	LNL + 40	LNL *	LNL - 10	LNH+5	LNL +15
2140	2100	1640	1600	1590	2105	815

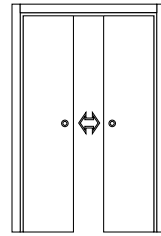

INSIDE THE WALL SLIDING OPENING WITH TWO OPPOSING LEAVES
 APERTURA SCORREVOLE INTERNO MURO A DUE ANTE CONTRAPPOSTE
 BELLINI - BONAPARTE - DANIELI - FORTE - JUVARRA - SAVINI

BELLINI - DANIELI - FORTE - JUVARRA - LUCCHINI - SAVINI
 APERTURA SCORREVOLE INTERNO MURO A DUE ANTE SOVRAPPOSTE SINGOLE
 OUTSIDE THE WALL SLIDING OPENING WITH TWO OVERLAPPING SINGLE LEAVES

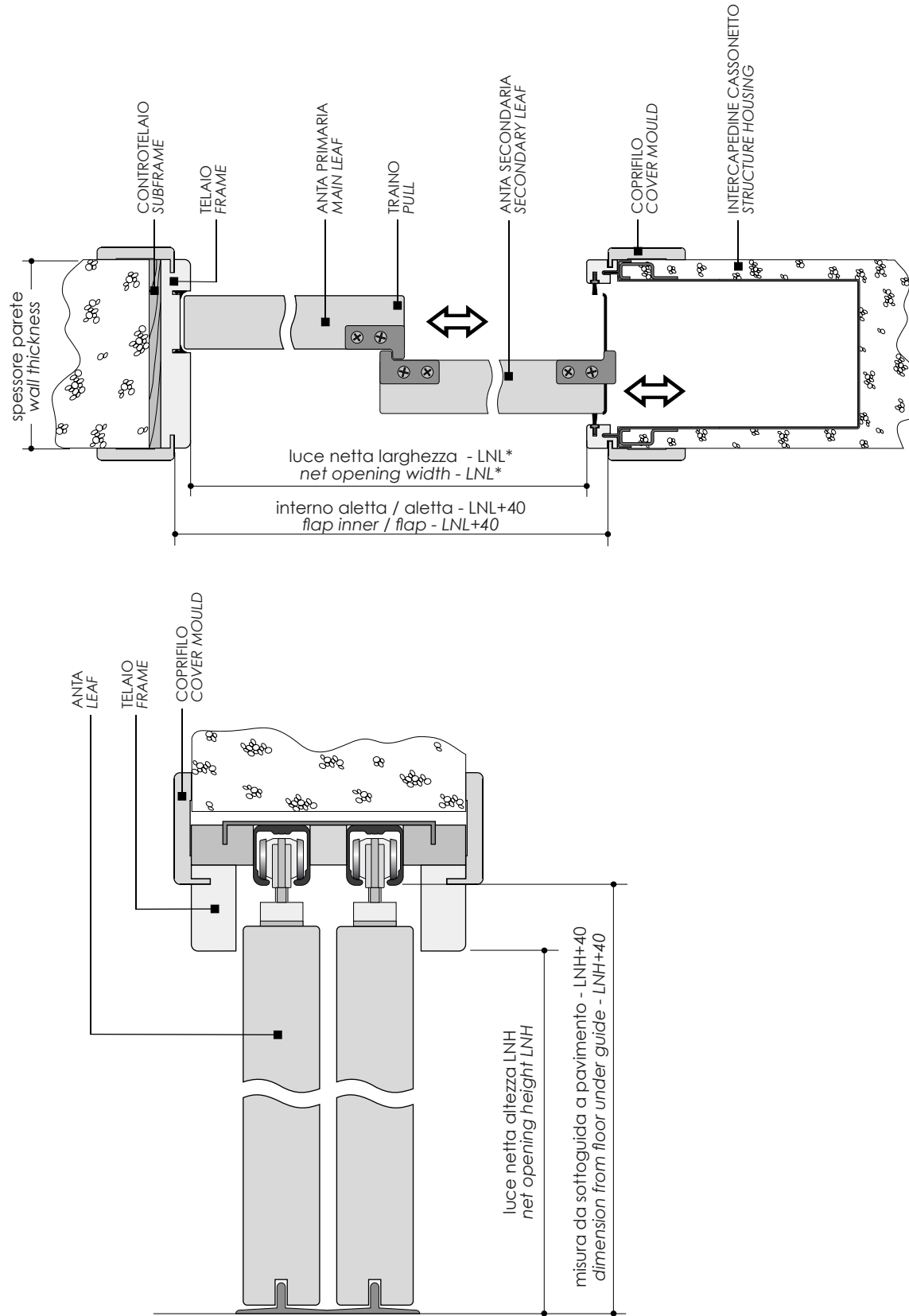
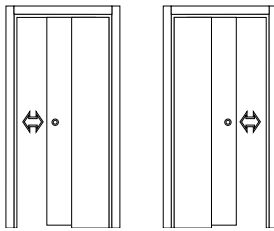

SVILUPPO MISURE ALTEZZA MEASUREMENTS DEVELOPMENT HEIGHT		SVILUPPO MISURE LARGHEZZA MEASUREMENTS DEVELOPMENT WIDTH			DIMENSIONE ANTA LEAF DIMENSION	
MISURA DA SOTTOGUIDA DIMENSION FROM UNDER GUIDE	LUCE NETTA ALTEZZA NET OPENING HEIGHT	LUCE INTERNO ALETTA/ALETTA FLAP INNER DIMENSION / FLAP	LUCE LARGHEZZA NOMINALE NOMINAL OPENING WIDTH	LUCE LARGHEZZA REALE REAL OPENING WIDTH	ALTEZZA ANTA LEAF HEIGHT	LARGHEZZA ANTA LEAF WIDTH
LNH + 40	LNH	LNL + 40	LNL *	LNL - 10	LNH+5	LNL +15
2140	2100	1640	1600	1590	2105	818

TUTTI I RIFERIMENTI CON L'ASTERISCO (*) SONO DA INDICARE NELL'ORDINE PER LA CONFIGURAZIONE STANDARD CORRETTA TELAI / COPRIFILO DI OGNI FAMIGLIA. CONSULTARE IL LISTINO ALL REFERENCES BEARING THE ASTERISCS (*) MUST BE INDICATED IN THE ORDER CONSULT THE PRICELIST FOR THE CORRECT STANDARD CONFIGURATION OF FRAME / COVER MOULD OF EACH FAMILY

TUTTI I RIFERIMENTI CON L'ASTERISCO (*) SONO DA INDICARE NELL'ORDINE PER LA CONFIGURAZIONE STANDARD CORRETTA. TELAI0 / COPRIFILO DI OGNI FAMIGLIA CONSULTARE IL LISTINO ALL REFERENCES BEARING THE ASTERISCS (*) MUST BE INDICATED IN THE ORDER CONSULT THE PRICELIST FOR THE CORRECT STANDARD CONFIGURATION OF FRAME / COVER MOULD OF EACH FAMILY

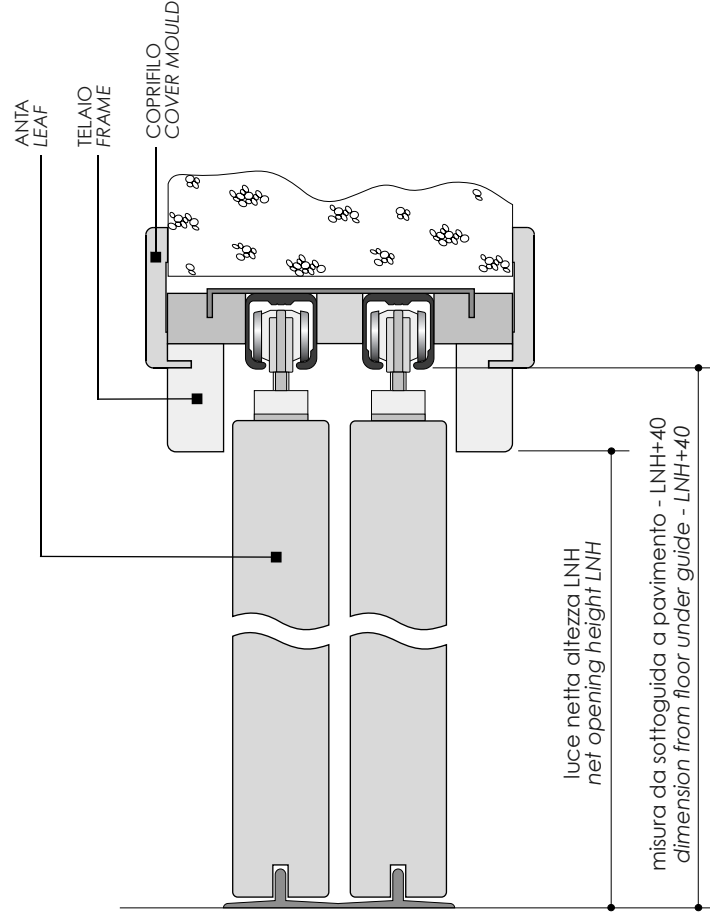
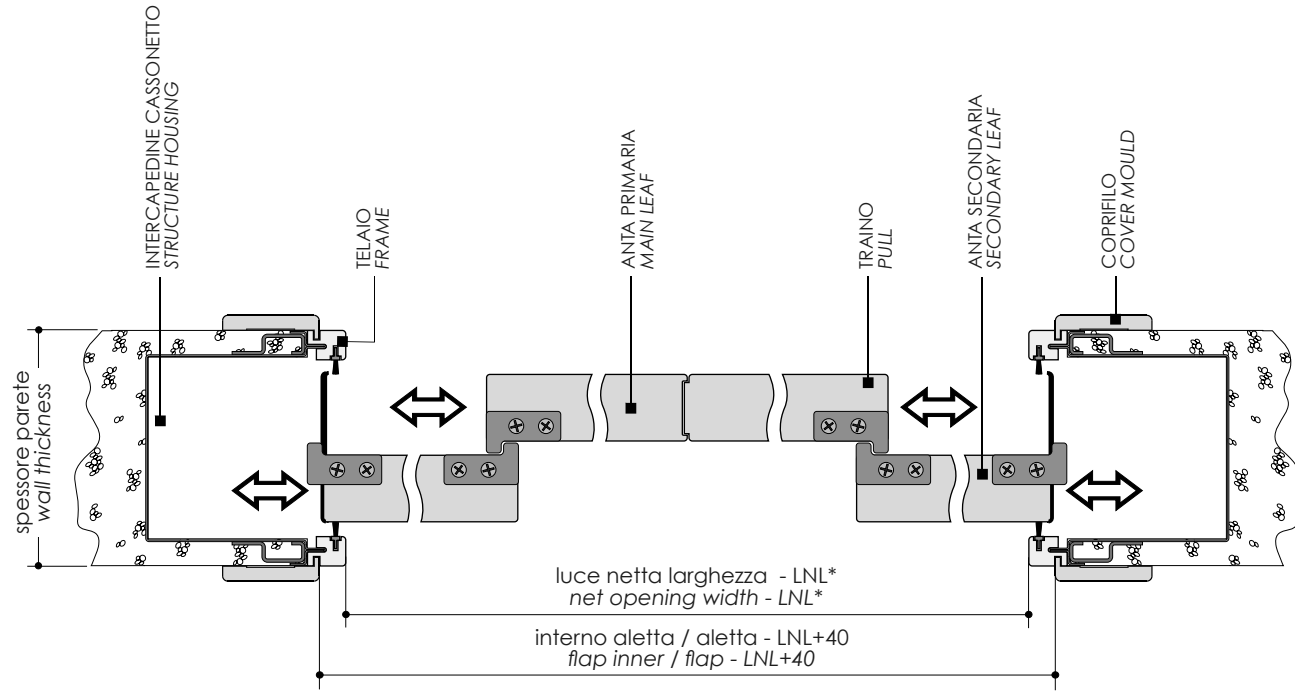

SVILUPPO MISURE ALTEZZA MEASUREMENTS DEVELOPMENT HEIGHT		SVILUPPO MISURE LARGHEZZA MEASUREMENTS DEVELOPMENT WIDTH			DIMENSIONE ANTA LEAF DIMENSION	
MISURA DA SOTTOGUIDA DIMENSION FROM UNDER GUIDE	MISURA DA SOTTOGUIDA DIMENSION FROM UNDER GUIDE	LUCE INTERNO ALETTA/ALETTA FLAP INNER DIMENSION / FLAP	LUCE LARGHEZZA NOMINALE NOMINAL OPENING WIDTH	LUCE LARGHEZZA REALE REAL OPENING WIDTH	ALTEZZA ANTA LEAF HEIGHT	LARGHEZZA ANTA LEAF WIDTH
LNH + 40	LNH	LNL*	LNL 1	LNL +40	LNH+5	LNL +15
2140	2100	2800	698	2840	2105	714

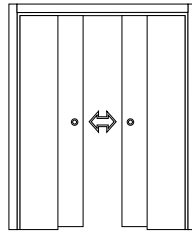

OUTSIDE THE WALL SLIDING OPENING WITH TWO OVERLAPPING DOUBLE LEAVES
 APERTURA SCORREVOLE INTERNO MURO A DUE ANTE SOVRAPPOSTE DOPPIE
 BELLINI - DANIELI - FORTE - JUVARRA - LUCCHINI - SAVINI

BELLINI - DANIELI - FORTE - JUVARRA - LUCCHINI - SAVINI
 APERTURA PIEGHEVOLE AD UN'ANTA
 SINGLE LEAF FOLDING OPENING

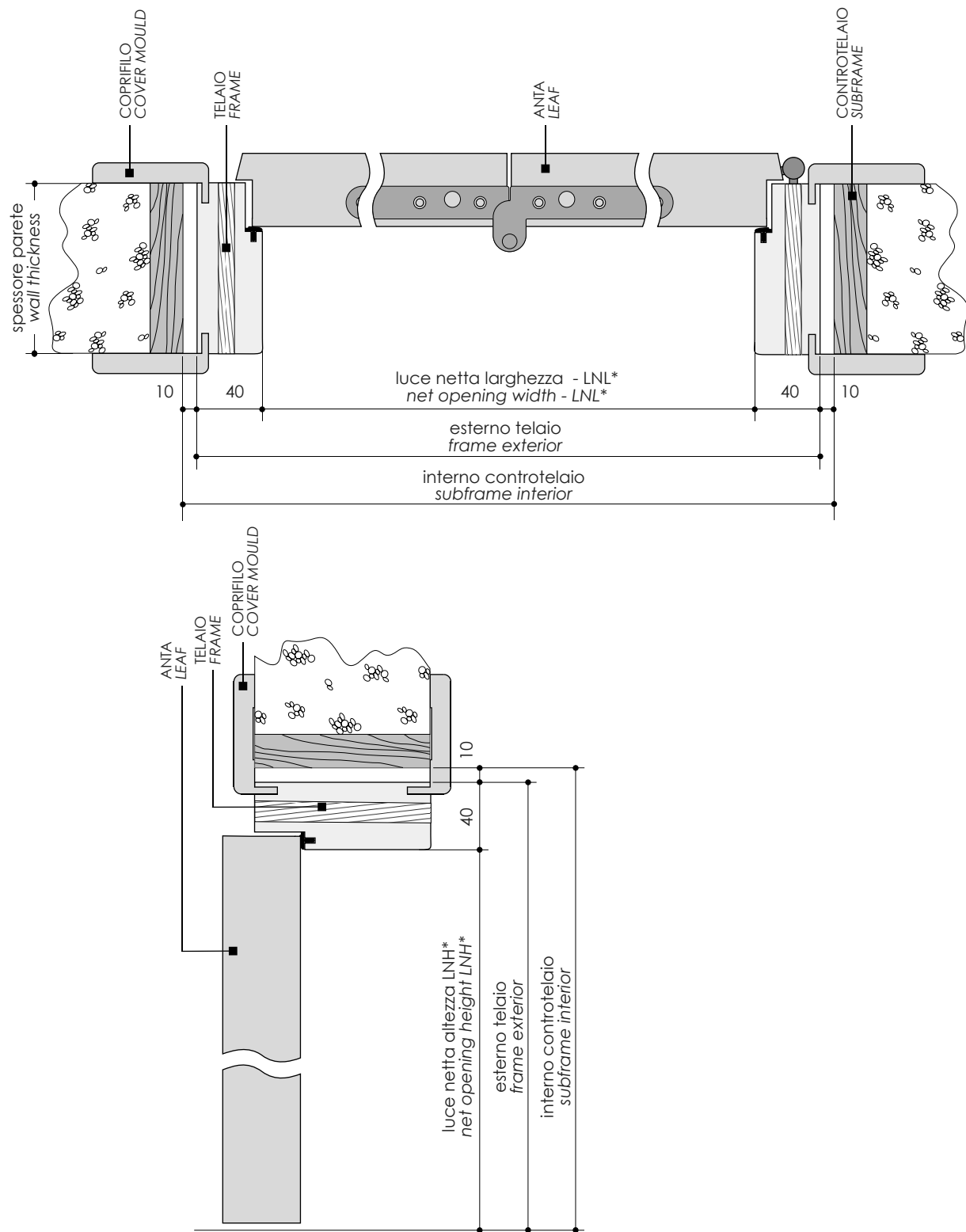
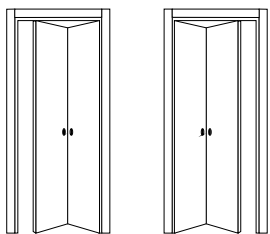

TUTTI I RIFERIMENTI CON L'ASTERISCO (*) SONO DA INDICARE NELL'ORDINE
 PER LA CONFIGURAZIONE STANDARD CORRETTA TELAIΟ / COPRIFILO DI OGNI FAMIGLIA CONSULTARE IL LISTINO
 ALL REFERENCES BEARING THE ASTERISCS (*) MUST BE INDICATED IN THE ORDER
 CONSULT THE PRICELIST FOR THE CORRECT STANDARD CONFIGURATION OF FRAME / COVER MOULD OF EACH FAMILY

SVILUPPO MISURE ALTEZZA MEASUREMENTS DEVELOPMENT HEIGHT			SVILUPPO MISURE LARGHEZZA MEASUREMENTS DEVELOPMENT WIDTH		
INTERNO CONTROTELAIO SUBFRAME INTERIOR	ESTERNO TELAIΟ FRAME EXTERIOR	LUCE NETTA ALTEZZA NET OPENING HEIGHT	INTERNO CONTROTELAIO SUBFRAME INTERIOR	ESTERNO TELAIΟ FRAME EXTERIOR	LUCE NETTA LARGHEZZA TOTAL NET OPENING WIDTH
LNH + 50	LNH + 40	LNH	LNL + 100	LNL + 80	LNL
2150	2140	2100	900	880	800

TUTTI I RIFERIMENTI CON L'ASTERISCO (*) SONO DA INDICARE NELL'ORDINE PER LA CONFIGURAZIONE STANDARD CORRETTA TELAIO / COPRIFILO DI OGNI FAMIGLIA CONSULTARE IL LISTINO ALL REFERENCES BEARING THE ASTERISCS (*) MUST BE INDICATED IN THE ORDER CONSULT THE PRICELIST FOR THE CORRECT STANDARD CONFIGURATION OF FRAME / COVER MOULD OF EACH FAMILY

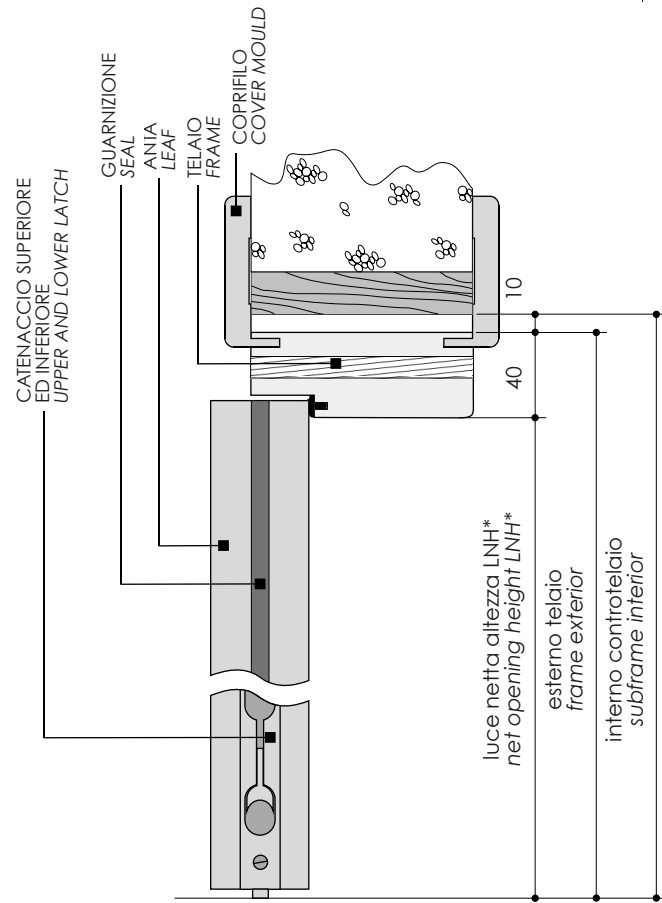
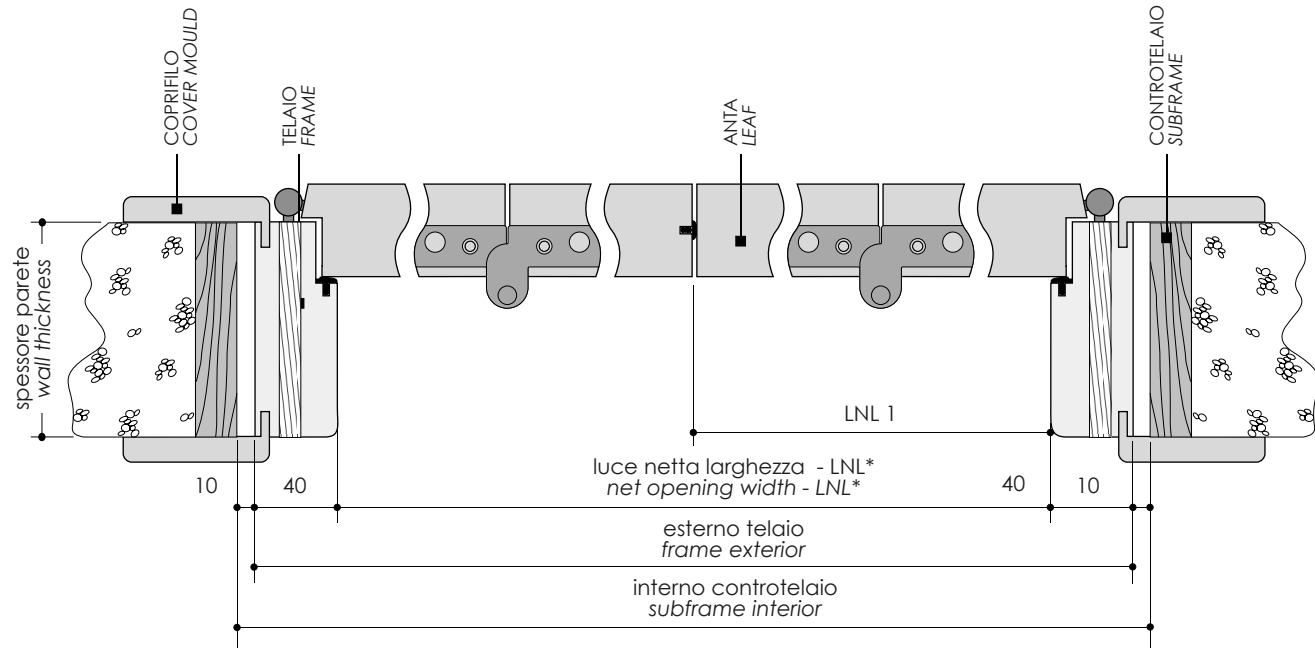

SVILUPPO MISURE ALTEZZA MEASUREMENTS DEVELOPMENT HEIGHT			SVILUPPO MISURE LARGHEZZA MEASUREMENTS DEVELOPMENT WIDTH		
INTERNO CONTROTELAIO SUBFRAME INTERIOR	ESTERNO TELAIO FRAME EXTERIOR	LUCE NETTA ALTEZZA NET OPENING HEIGHT	INTERNO CONTROTELAIO SUBFRAME INTERIOR	ESTERNO TELAIO FRAME EXTERIOR	LUCE NETTA LARGHEZZA TOTAL NET OPENING WIDTH
LNH + 50	LNH + 40	LNH	LNL + 100	LNL + 80	LNL
2150	2140	2100	1500	1480	1400

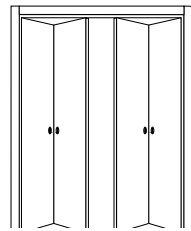

DOUBLE LEAF FOLDING OPENING
APERTURA PIEGHEVOLE A DUE ANTE
BELLINI - DANIELI - FORTE

BELLINI - DANIELI - FORTE - JUVARRA - LUCCHINI - SAVINI
 APERTURA SCORREVOLE ESTERNO MURO AD UN'ANTA
 SINGLE LEAF OUTSIDE THE WALL SLIDING OPENING

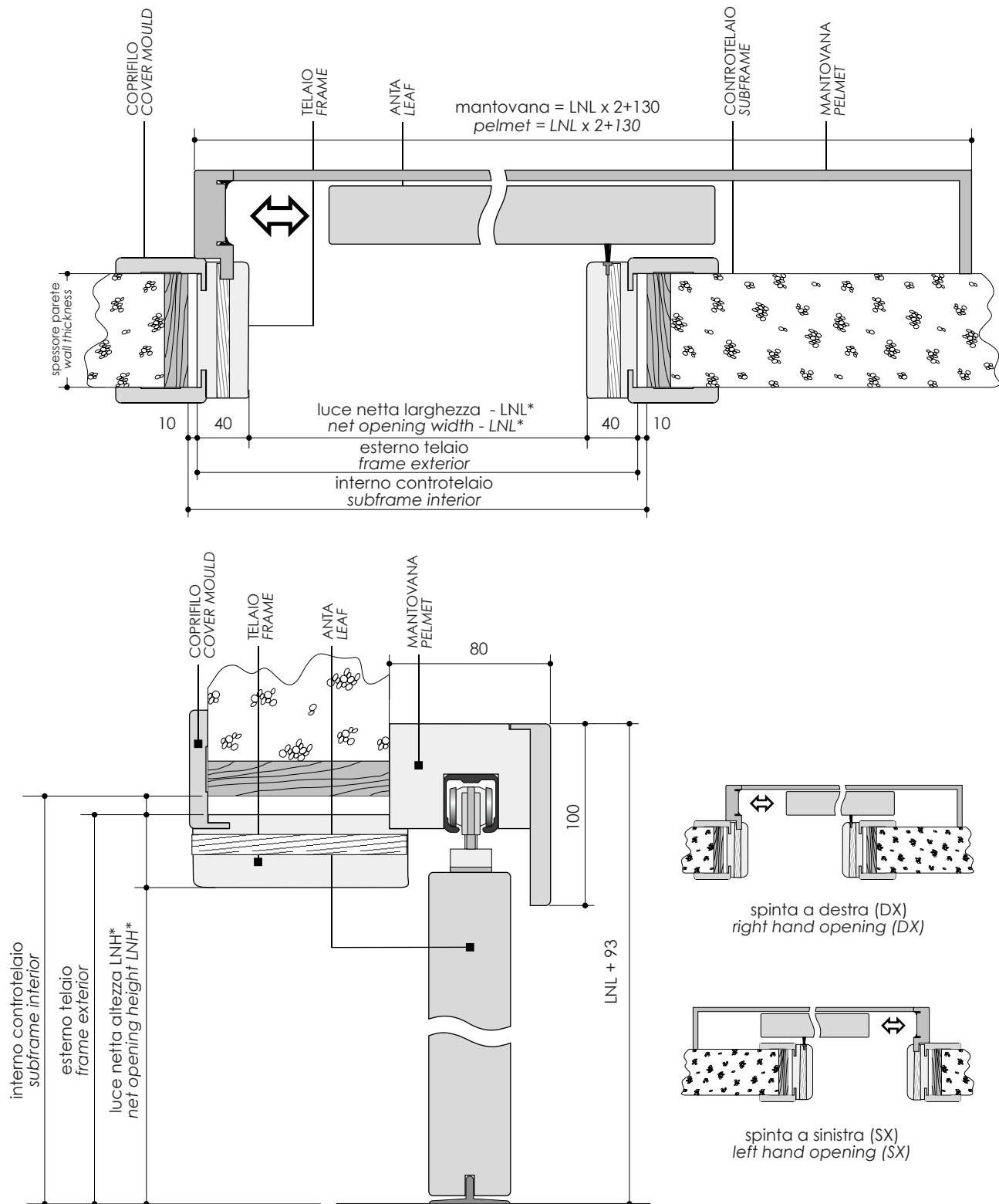
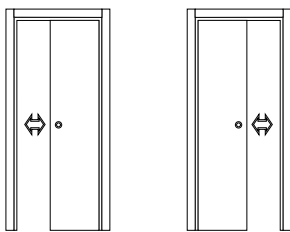

SVILUPPO MISURE ALTEZZA MEASUREMENTS DEVELOPMENT HEIGHT			SVILUPPO MISURE LARGHEZZA MEASUREMENTS DEVELOPMENT WIDTH			DIMENSIONE ANTA LEAF DIMENSION	
INTERNO CONTROTELAIO SUBFRAME INTERIOR	ESTERNO TELAIO FRAME EXTERIOR	LUCE NETTA ALTEZZA NET OPENING HEIGHT	INTERNO CONTROTELAIO SUBFRAME INTERIOR	ESTERNO TELAIO FRAME EXTERIOR	LUCE NETTA LARGHEZZA NET OPENING WIDTH	ALTEZZA ANTA LEAF HEIGHT	LARGHEZZA ANTA LEAF WIDTH
LNH + 50	LNH + 40	LNH	LNL + 100	LNL + 80	LNL	LNH + 15	LNL + 45
2150	2140	2100	900	880	800	2115	845

TUTTI I RIFERIMENTI CON L'ASTERISCO (*) SONO DA INDICARSI
 PER LA CONFIGURAZIONE STANDARD CORRETTA TELAIO / COPRIFILO DI OGNI FAMIGLIA CONSULTARE IL LISTINO
 ALL REFERENCES BEARING THE ASTERISCS (*) MUST BE INDICATED IN THE ORDER
 CONSULT THE PRICELIST FOR THE CORRECT STANDARD CONFIGURATION OF FRAME / COVER MOULD OF EACH FAMILY

TUTTI I RIFERIMENTI CON L'ASTERISCO (*) SONO DA INDICARE NELL'ORDINE PER LA CONFIGURAZIONE STANDARD CORRETTA TELAIO / COPRIFILO DI OGNI FAMIGLIA CONSULTARE IL LISTINO ALL REFERENCES BEARING THE ASTERISCS (*) MUST BE INDICATED IN THE ORDER CONSULT THE PRICELIST FOR THE CORRECT STANDARD CONFIGURATION OF FRAME / COVER MOULD OF EACH FAMILY

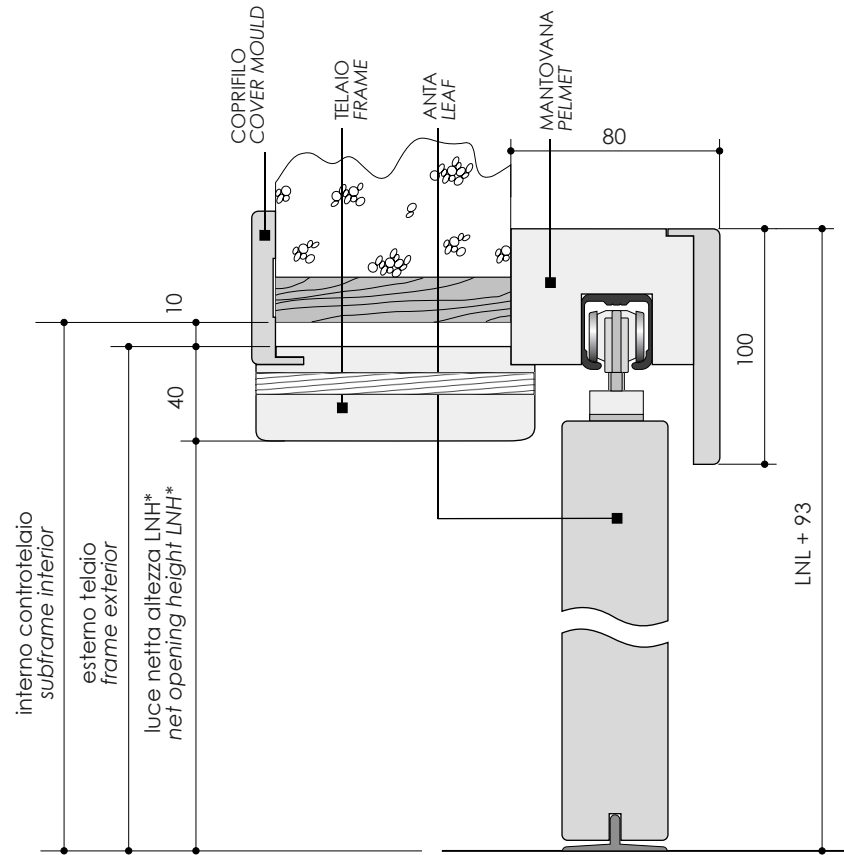
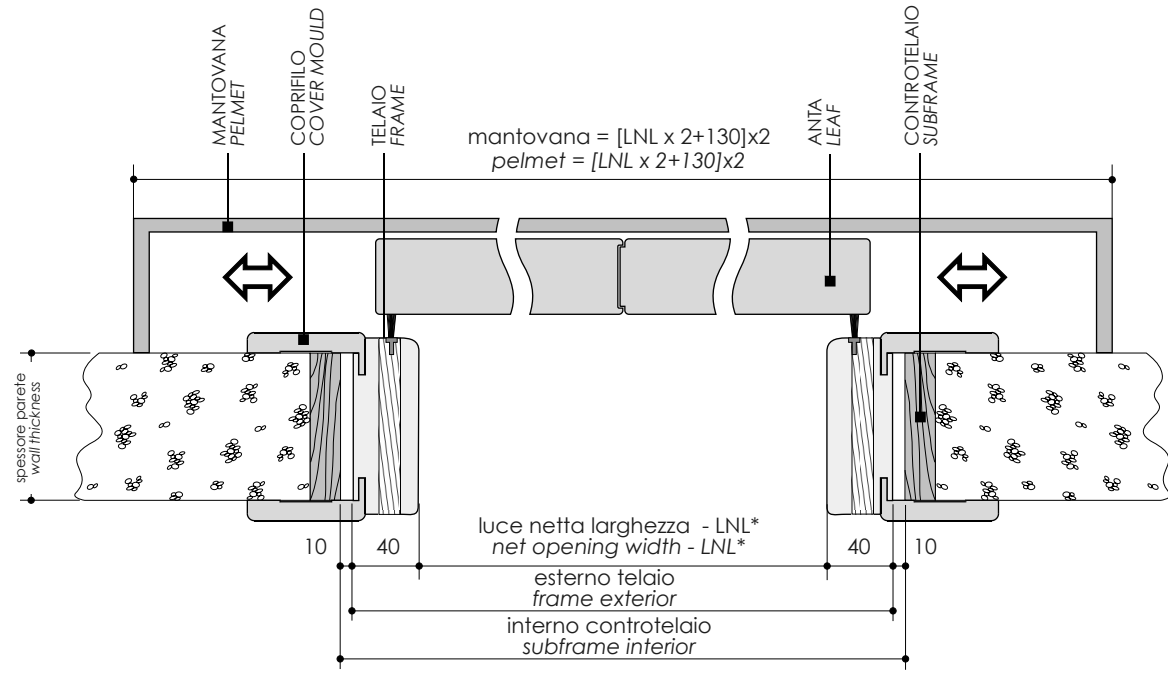

SVILUPPO MISURE ALTEZZA MEASUREMENTS DEVELOPMENT HEIGHT			SVILUPPO MISURE LARGHEZZA MEASUREMENTS DEVELOPMENT WIDTH			DIMENSIONE ANTA LEAF DIMENSION	
INTERNO CONTROTELAIO SUBFRAME INTERIOR	ESTERNO TELAIO FRAME EXTERIOR	LUCE NETTA ALTEZZA NET OPENING HEIGHT	INTERNO CONTROTELAIO SUBFRAME INTERIOR	ESTERNO TELAIO FRAME EXTERIOR	LUCE NETTA LARGHEZZA NET OPENING WIDTH	ALTEZZA ANTA LEAF HEIGHT	LARGHEZZA ANTA LEAF WIDTH
LNH + 50	LNH + 40	LNH	LNL + 100	LNL + 80	LNL	LNH + 15	LNL + 45
2150	2140	2100	1700	1680	1600	2115	837

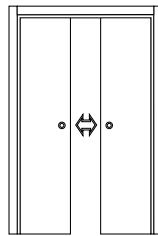

OUTSIDE THE WALL SLIDING OPENING WITH TWO OPPOSING LEAVES
 APERTURA SCORREVOLE ESTERNO MURO A DUE ANTE CONTRAPPOSTE
 BELLINI - DANIELI - FORTE - JUVARRA - LUCCHINI - SAVINI

BELLINI - DANIELI - FORTE - JUVARRA - LUCCHINI - SAVINI
 APERTURA SCORREVOLE ESTERNO MURO A DUE ANTE SOVRAPPOSTE SINGOLE
 OUTSIDE THE WALL SLIDING OPENING WITH TWO OVERLAPPING SINGLE LEAVES

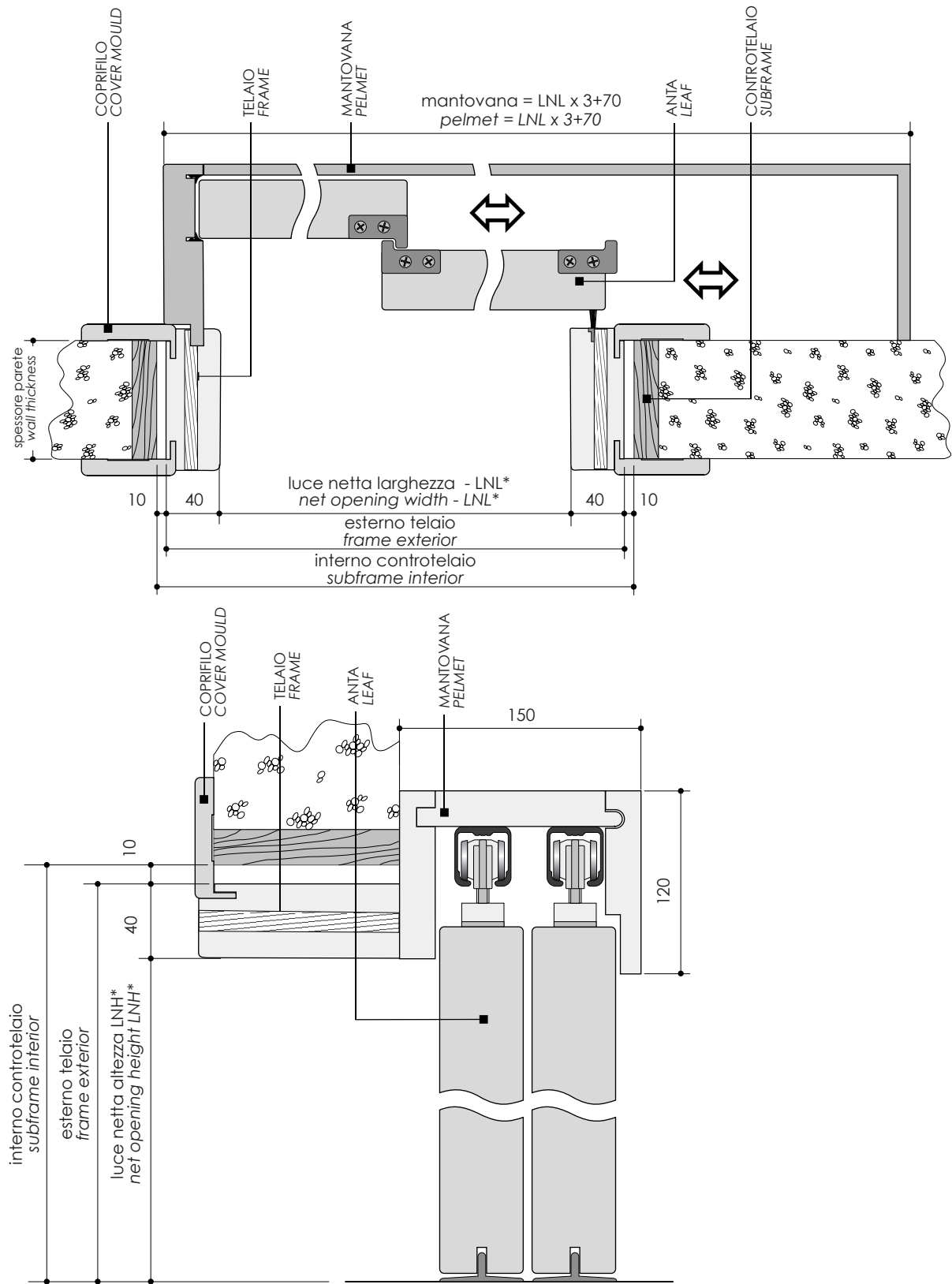
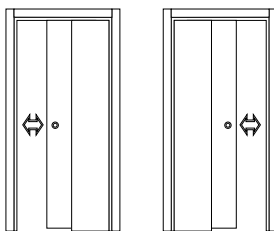

SVILUPPO MISURE ALTEZZA MEASUREMENTS DEVELOPMENT HEIGHT			SVILUPPO MISURE LARGHEZZA MEASUREMENTS DEVELOPMENT WIDTH			DIMENSIONE ANTA LEAF DIMENSION	
INTERNO CONTRATELAIO SUBFRAME INTERIOR	ESTERNO TELAI FRAME EXTERIOR	LUCE NETTA ALTEZZA NET OPENING HEIGHT	INTERNO CONTRATELAIO SUBFRAME INTERIOR	ESTERNO TELAI FRAME EXTERIOR	LUCE NETTA LARGHEZZA NET OPENING WIDTH	ALTEZZA ANTA LEAF HEIGHT	LARGHEZZA ANTA LEAF WIDTH
LNH + 50	LNH + 40	LNH	LNL + 100	LNL + 80	LNL	LNH + 15	LNL + 45
2150	2140	2100	1700	1680	1600	2115	832

TUTTI I RIFERIMENTI CON L'ASTERISCO (*) SONO DA INDICARE NELL'ORDINE
 PER LA CONFIGURAZIONE STANDARD CORRETTA TELAI / COPRIFILO DI OGNI FAMIGLIA CONSULTARE IL LISTINO
 ALL REFERENCES BEARING THE ASTERISCS (*) MUST BE INDICATED IN THE ORDER
 CONSULT THE PRICELIST FOR THE CORRECT STANDARD CONFIGURATION OF FRAME / COVER MOULD OF EACH FAMILY

TUTTI I RIFERIMENTI CON L'ASTERISCO (*) SONO DA INDICARE NELL'ORDINE PER LA CONFIGURAZIONE STANDARD CORRETTA TELAIO / COPRIFILO DI OGNI FAMIGLIA CONSULTARE IL LISTINO ALL REFERENCES BEARING THE ASTERISCS (*) MUST BE INDICATED IN THE ORDER CONSULT THE PRICELIST FOR THE CORRECT STANDARD CONFIGURATION OF FRAME / COVER MOULD OF EACH FAMILY

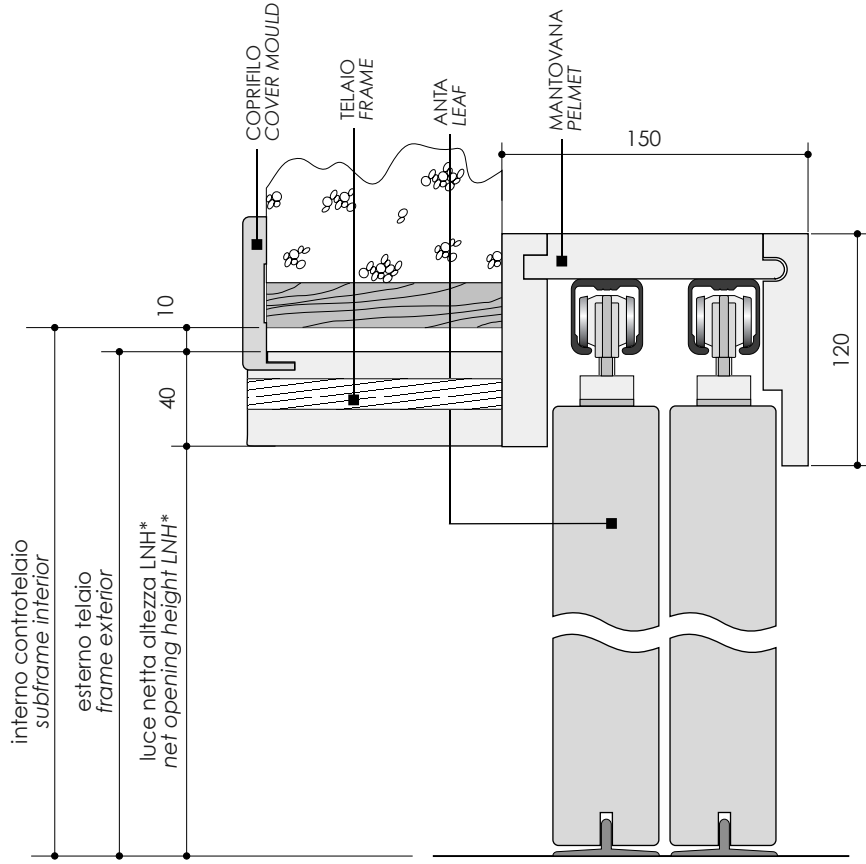
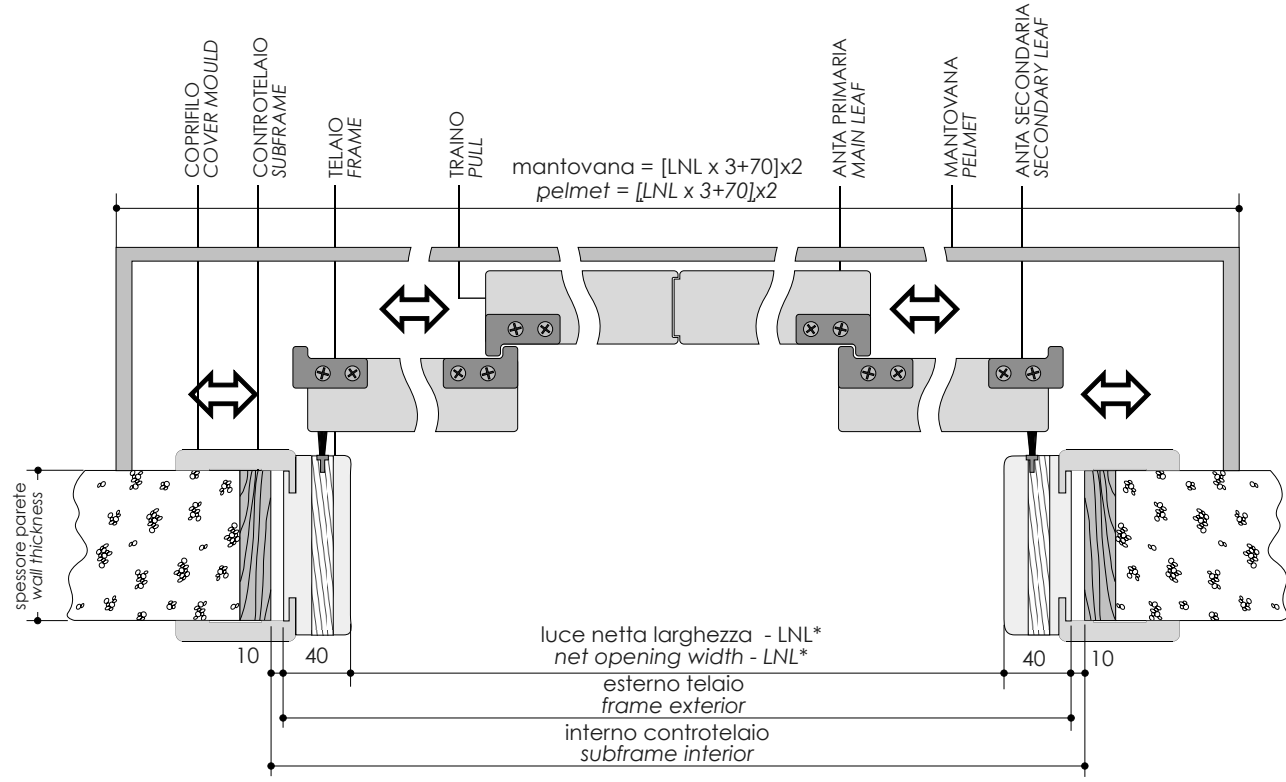

SVILUPPO MISURE ALTEZZA MEASUREMENTS DEVELOPMENT HEIGHT			SVILUPPO MISURE LARGHEZZA MEASUREMENTS DEVELOPMENT WIDTH			DIMENSIONE ANTA LEAF DIMENSION	
INTERNO CONTROTELAIO SUBFRAME INTERIOR	ESTERNO TELAIO FRAME EXTERIOR	LUCE NETTA ALTEZZA NET OPENING HEIGHT	INTERNO CONTROTELAIO SUBFRAME INTERIOR	ESTERNO TELAIO FRAME EXTERIOR	LUCE NETTA LARGHEZZA NET OPENING WIDTH	ALTEZZA ANTA LEAF HEIGHT	LARGHEZZA ANTA LEAF WIDTH
LNH + 50	LNH + 40	LNH	LNL + 100	LNL + 80	LNL	LNH + 15	LNL + 45
2150	2140	2100	2900	2880	2800	2115	743

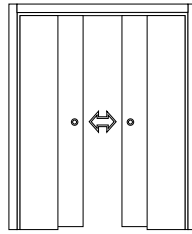

OUTSIDE THE WALL SLIDING OPENING WITH TWO OVERLAPPING DOUBLE LEAVES
 APERTURA SCORREVOLE ESTERNO MURO A DUE ANTE SOVRAPPOSTE DOPPIE
 BELLINI - DANIELI - FORTE - JUVARRA - LUCCHINI - SAVINI

DANIELI U - FORTE 6 - SAVINI 1
 APERTURA SCORREVOLE ESTERNO MURO AD UN'ANTA CON MANTOVANA NASCOSTA
 OUTSIDE THE WALL SLIDING OPENING SINGLE LEAF WITH PELMET

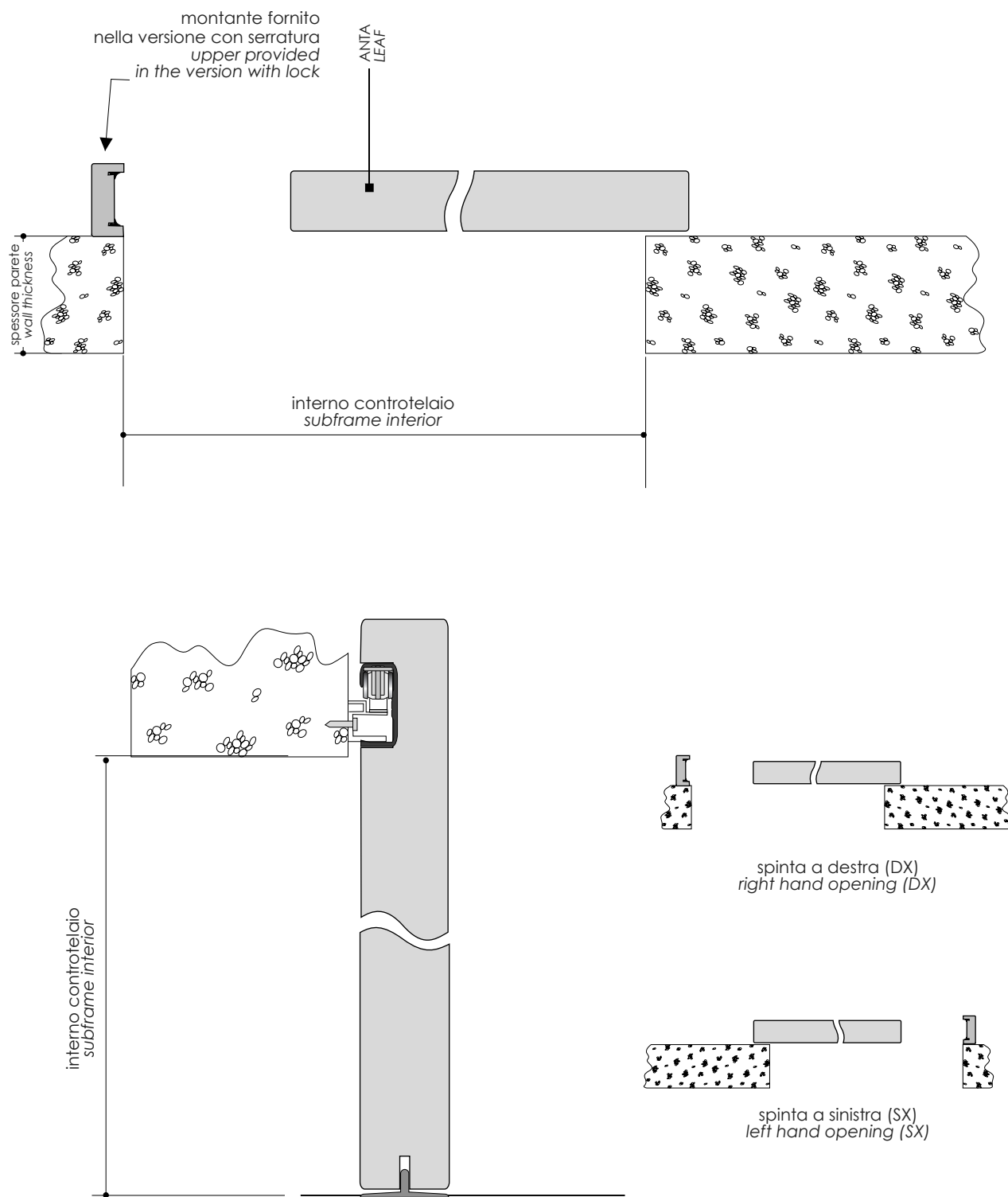
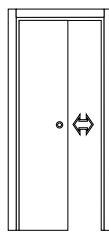
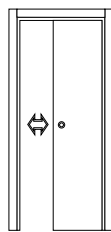

TUTTI I RIFERIMENTI CON L'ASTERISCO (*) SONO DA INDICARE NELL'ORDINE
 PER LA CONFIGURAZIONE STANDARD CORRETTA TELAIO / COPRIFILDI OGNI FAMIGLIA CONSULTARE IL LISTINO
 ALL REFERENCES BEARING THE ASTERISCS (*) MUST BE INDICATED IN THE ORDER
 CONSULT THE PRICELIST FOR THE CORRECT STANDARD CONFIGURATION OF FRAME / COVER MOULD OF EACH FAMILY

TUTTI I RIFERIMENTI CON L'ASTERISCO (*) SONO DA INDICARE NELL'ORDINE L'INDICAZIONE DELLA SPINTA È NECESSARIA ESCLUSIVAMENTE PER LE PORTE VEIRATE, AL FINE DI SEGNALARNE LA PARTE A VISTA DEL VETRO PER LA CONFIGURAZIONE STANDARD CORRETTA TELAIO / COPRIFILO DI OGNI FAMIGLIA. CONSULTARE IL LISTINO
 ALL REFERENCES BEARING THE ASTERISCS (*) MUST BE INDICATED IN THE ORDER THE OPENING HAND INDICATION IS NECESSARY SOLELY FOR GLAZED DOORS SO AS TO INDICATE THE GLASS PRESENCE CONSULT THE PRICELIST FOR THE CORRECT STANDARD CONFIGURATION OF FRAME / COVER MOULD OF EACH FAMILY

SVILUPPO MISURE ALTEZZA MEASUREMENTS DEVELOPMENT HEIGHT			SVILUPPO MISURE LARGHEZZA MEASUREMENTS DEVELOPMENT WIDTH		
INTERNO CONTROTELAIO SUBFRAME INTERIOR	ESTERNO TELAIO FRAME EXTERIOR	LUCE NETTA ALTEZZA NET OPENING HEIGHT	INTERNO CONTROTELAIO SUBFRAME INTERIOR	ESTERNO TELAIO FRAME EXTERIOR	LUCE NETTA LARGHEZZA NET OPENING WIDTH
LNH + 50	LNH + 40	LNH	LNL + 100	LNL + 80	LNL
2150	2140	2100	900	880	800

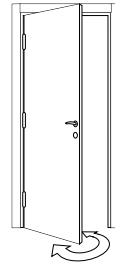
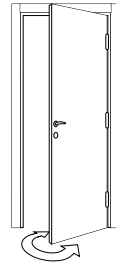
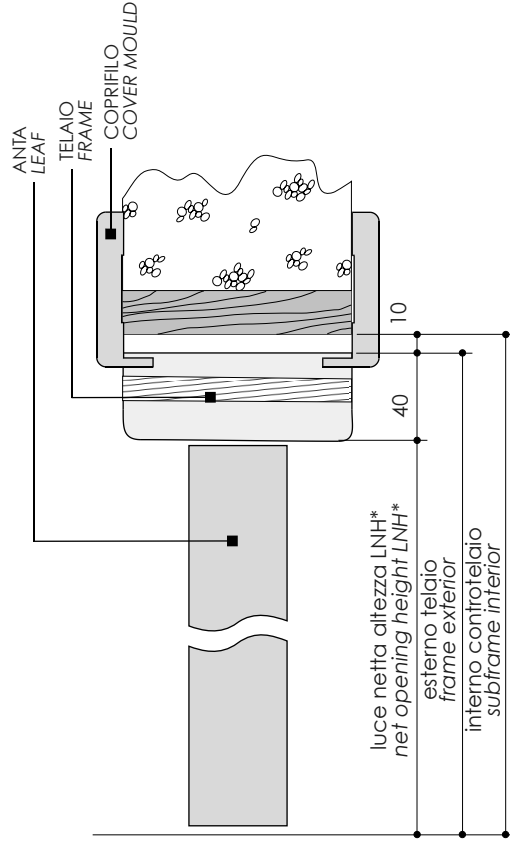
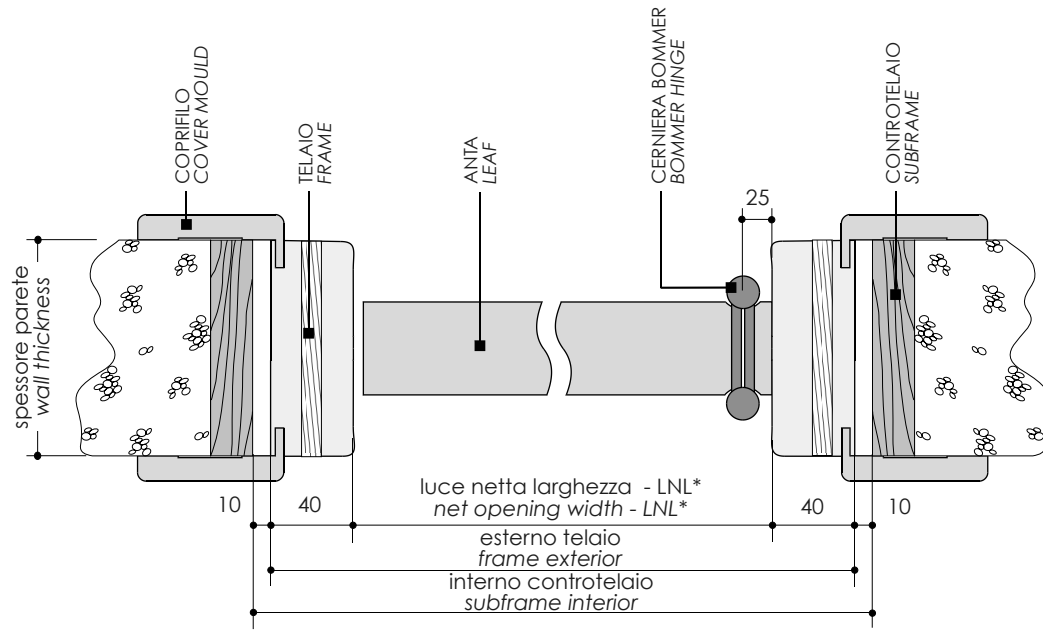

SINGLE LEAF OPENING WITH BOMMER HINGE
 APERTURA CON CERNIERA BOMMER AD UN'ANTA
 BELLINI - DANIELI - FORTE - JUVARRA - LUCCHINI - SAVINI

BELLINI - DANIELI - FORTE - JUVARRA - LUCCHINI - SAVINI
APERTURA CON CERNIERA BOMMER A DUE ANTE
DOUBLE LEAF OPENING WITH BOMMER HINGE

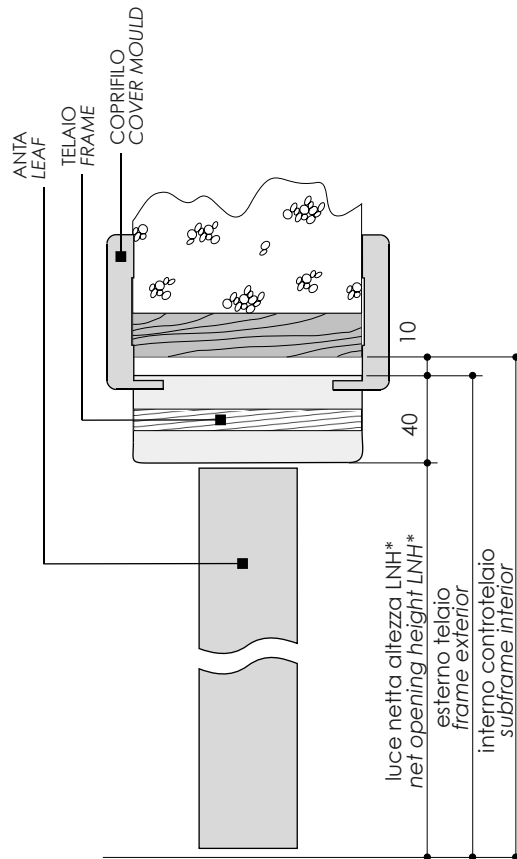
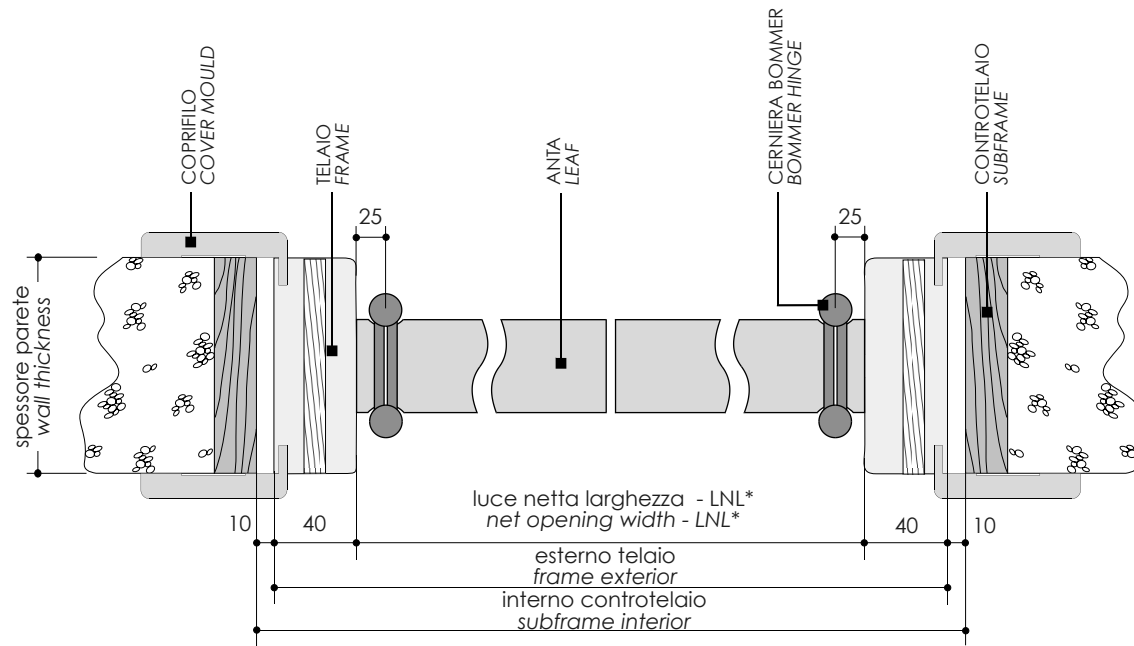
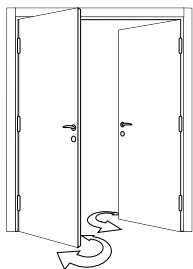

SVILUPPO MISURE ALTEZZA MEASUREMENTS DEVELOPMENT HEIGHT			SVILUPPO MISURE LARGHEZZA MEASUREMENTS DEVELOPMENT WIDTH		
INTERNO CONTROTELAIO SUBFRAME INTERIOR	ESTERNO TELAIΟ FRAME EXTERIOR	LUCE NETTA ALTEZZA NET OPENING HEIGHT	INTERNO CONTROTELAIO SUBFRAME INTERIOR	ESTERNO TELAIΟ FRAME EXTERIOR	LUCE NETTA LARGHEZZA NET OPENING WIDTH
LNH + 50	LNH + 40	LNH	LNL + 100	LNL + 80	LNL
2150	2140	2100	1500	1480	1400

TUTTI I RIFERIMENTI CON L'ASTERISCO (*) SONO DA INDICARE NELL'ORDINE
 PER LA CONFIGURAZIONE STANDARD CORRETTA TELAIΟ / COPRIFILO DI OGNI FAMIGLIA CONSULTARE IL LISTINO
 ALL REFERENCES BEARING THE ASTERISCS (*) MUST BE INDICATED IN THE ORDER
 CONSULT THE PRICELIST FOR THE CORRECT STANDARD CONFIGURATION OF FRAME / COVER MOULD OF EACH FAMILY

TUTTI I RIFERIMENTI CON L'ASTERISCO (*) SONO DA INDICARE NELL'ORDINE
 QUESTO TIPO DI SOLUZIONE È POSSIBILE SOLO CON IL COPRIFILO M20
 ALL REFERENCES BEARING THE ASTERISCS (*) MUST BE INDICATED IN THE ORDER
 THIS TYPE OF SOLUTION IS POSSIBLE ONLY WITH THE M20 COVER MOULD

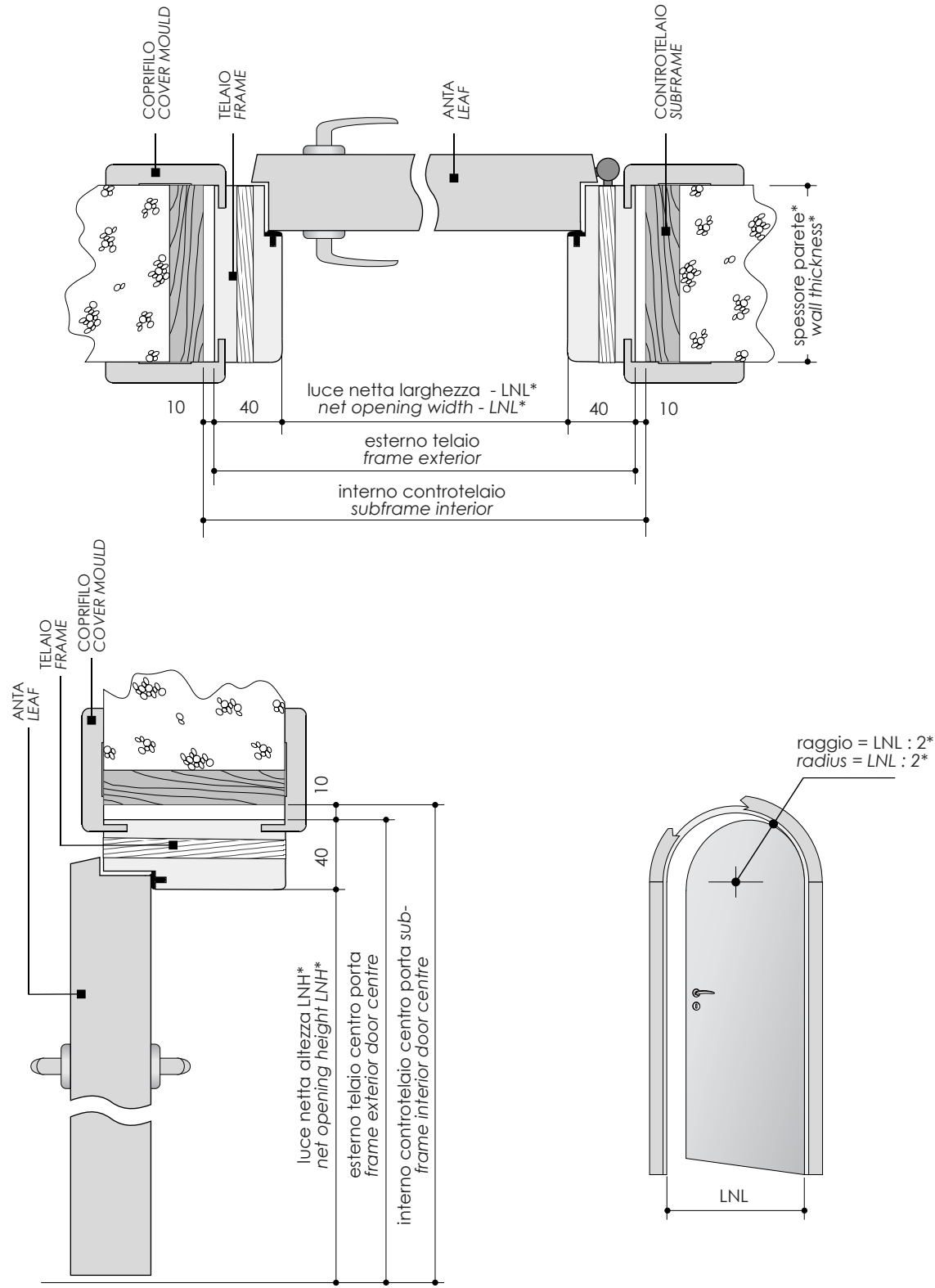

SVILUPPO MISURE ALTEZZA MEASUREMENTS DEVELOPMENT HEIGHT			SVILUPPO MISURE LARGHEZZA MEASUREMENTS DEVELOPMENT WIDTH		
INTERNO CONTROTELAIO SUBFRAME INTERIOR	ESTERNO TELAIO FRAME EXTERIOR	LUCE NETTA ALTEZZA NET OPENING HEIGHT	INTERNO CONTROTELAIO SUBFRAME INTERIOR	ESTERNO TELAIO FRAME EXTERIOR	LUCE NETTA LARGHEZZA NET OPENING WIDTH
LNH + 50	LNH + 40	LNH	LNL + 100	LNL + 80	LNL
2150	2140	2100	900	880	800

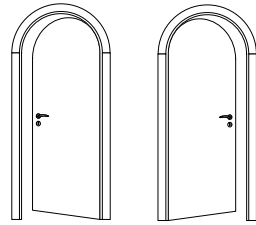

FULL ARCH SINGLE LEAF OPENING
 APERTURA AD UN'ANTA CENTINATA A TUTTO SESTO
 BELLINI - DANIELI - FORTE - JUVARRA - LUCCHINI

BELLINI - DANIELI - FORTE - JUVARRA - LUCCHINI - SAVINI
 APERTURA AD UN'ANTA TRAPEZOIDALE
 SINGLE LEAF SLANTED OPENING

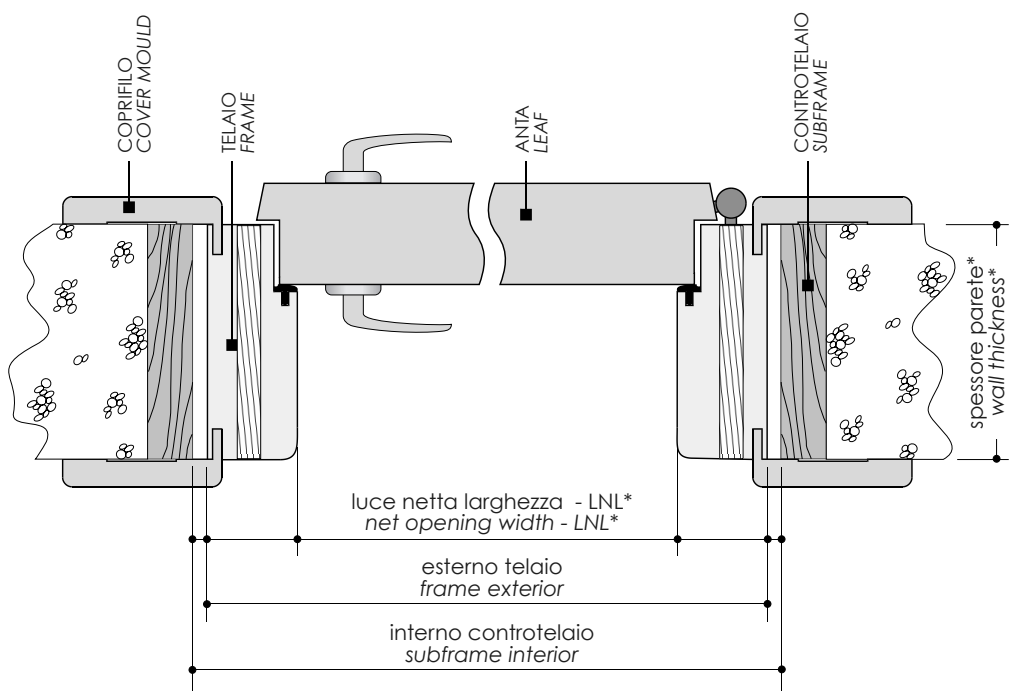
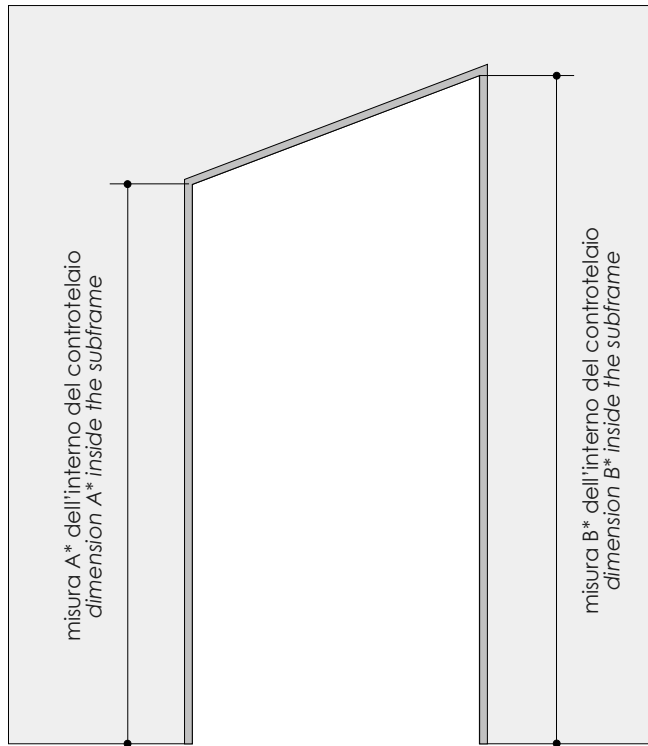
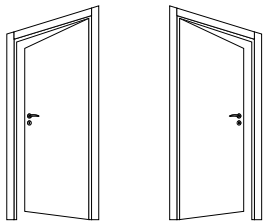

TUTTI I RIFERIMENTI CON L'ASTERISCO (*) SONO DA INDICARE NELL'ORDINE
 PER LA CONFIGURAZIONE STANDARD CORRETTA TELAI / COPRIFILO DI OGNI FAMIGLIA CONSULTARE IL LISTINO
 ALL REFERENCES BEARING THE ASTERISCS (*) MUST BE INDICATED IN THE ORDER
 CONSULT THE PRICELIST FOR THE CORRECT STANDARD CONFIGURATION OF FRAME / COVER MOULD OF EACH FAMILY

TUTTI I RIFERIMENTI CON L'ASTERISCO (*) SONO DA INDICARE NELL'ORDINE PER LA CONFIGURAZIONE STANDARD CORRETTA TELAI0 / COPRIFILO DI OGNI FAMIGLIA CONSULTARE IL LISTINO ALL REFERENCES BEARING THE ASTERISCS (*) MUST BE INDICATED IN THE ORDER CONSULT THE PRICELIST FOR THE CORRECT STANDARD CONFIGURATION OF FRAME / COVER MOULD OF EACH FAMILY

DETERMINAZIONE MISURE TAGLIO VETRO GLASS CUTTING DIMENSIONS CALCULATION	
ALTEZZA HEIGHT	LARGHEZZA WIDTH
esterno telaio sopraluce LNH - 104 frame exterior overhead doorlight LNH -104	esterno telaio sopraluce LNH - 64 frame exterior overhead doorlight LNH -64
2800 - 2100 - 104	900 - 64

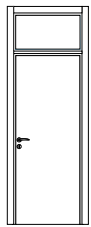
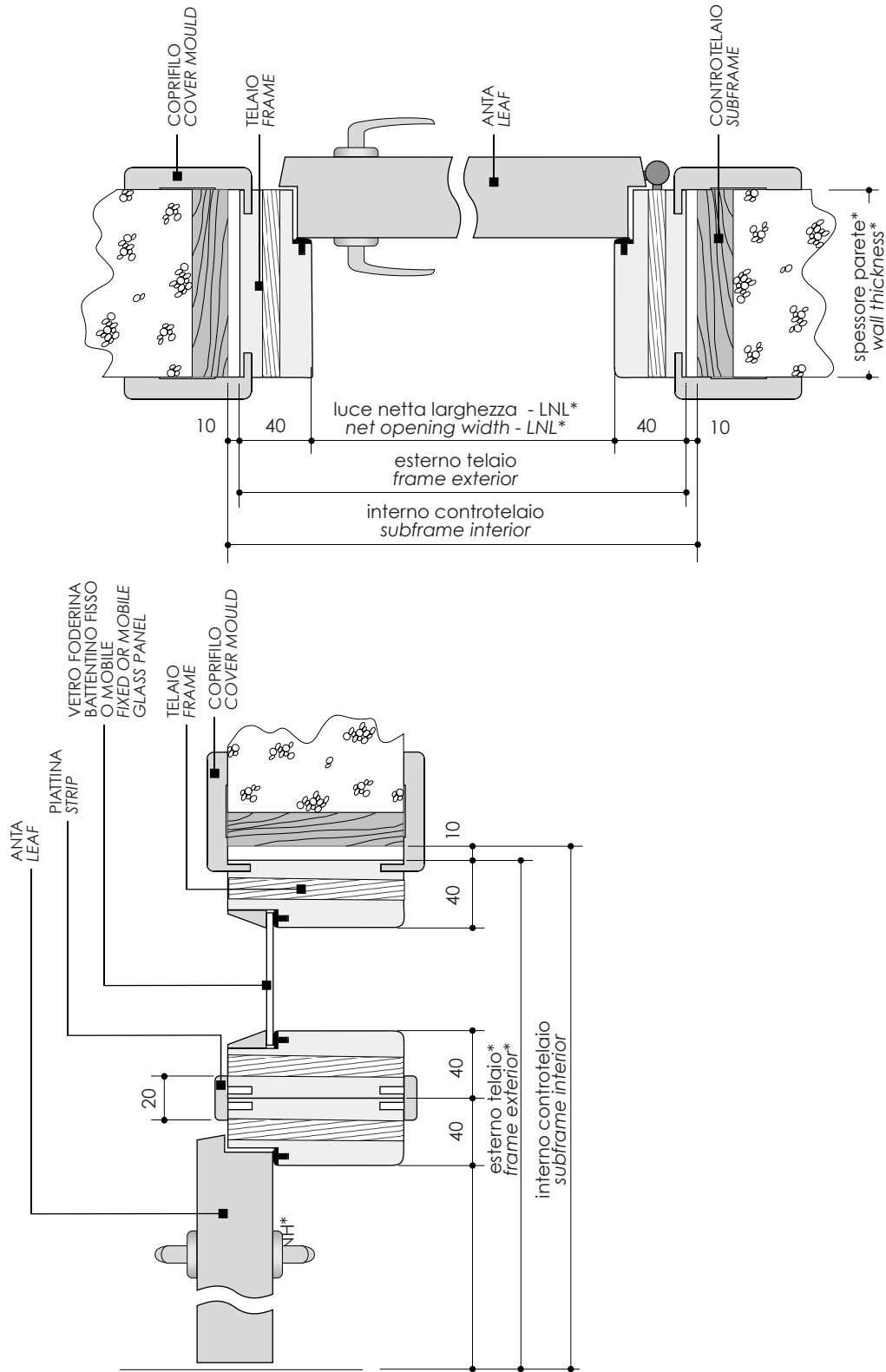

OPENING WITH OVERHEAD DOORLIGHT
 APERTURA CON SOPRALUCE
 BELLINI - DANIELI - FORTE - JUVARRA - LUCCHINI - SAVINI

BELLINI - DANIELI - FORTE - JUVARRA - LUCCHINI - SAVINI
 APERTURA CON FIANCOLUCE
 OPENING WITH SIDELIGHT

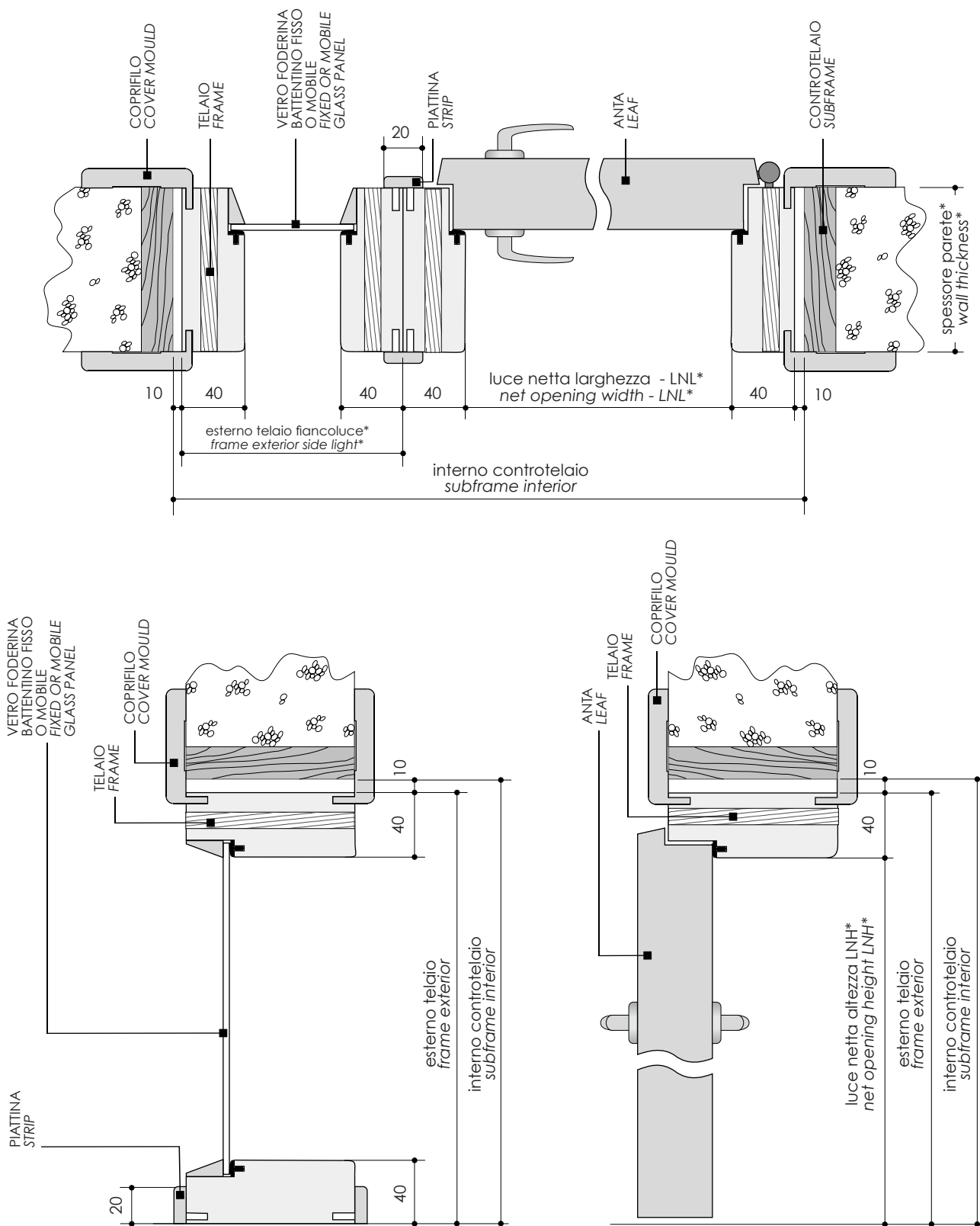
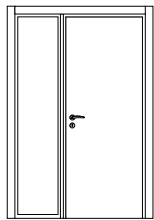

DETERMINAZIONE MISURE TAGLIO VETRO
 GLASS CUTTING DIMENSIONS CALCULATION

ALTEZZA HEIGHT	LARGHEZZA WIDTH
LNH - 24	esterno telaio fiancoluce - 64 frame exterior side light - 64
2100 - 24	400 - 64

TUTTI I RIFERIMENTI CON L'ASTERISCO (*) SONO DA INDICARE NELL'ORDINE PER LA CONFIGURAZIONE STANDARD CORRETTA TELAIO / COPRIFILO DI OGNI FAMIGLIA. CONSULTARE IL LISTINO ALL'REFERENZE BEARING THE ASTERISCS (*) MUST BE INDICATED IN THE ORDER CONSULT THE PRICELIST FOR THE CORRECT STANDARD CONFIGURATION OF FRAME / COVER MOULD OF EACH FAMILY

BELLINI - DANIELI - FORTE - JUVARRA - LUCCHINI - SAVINI
 APERTURA CON DOPPIO FIANCOLUCE
 OPENING WITH DOUBLE SIDELIGHT

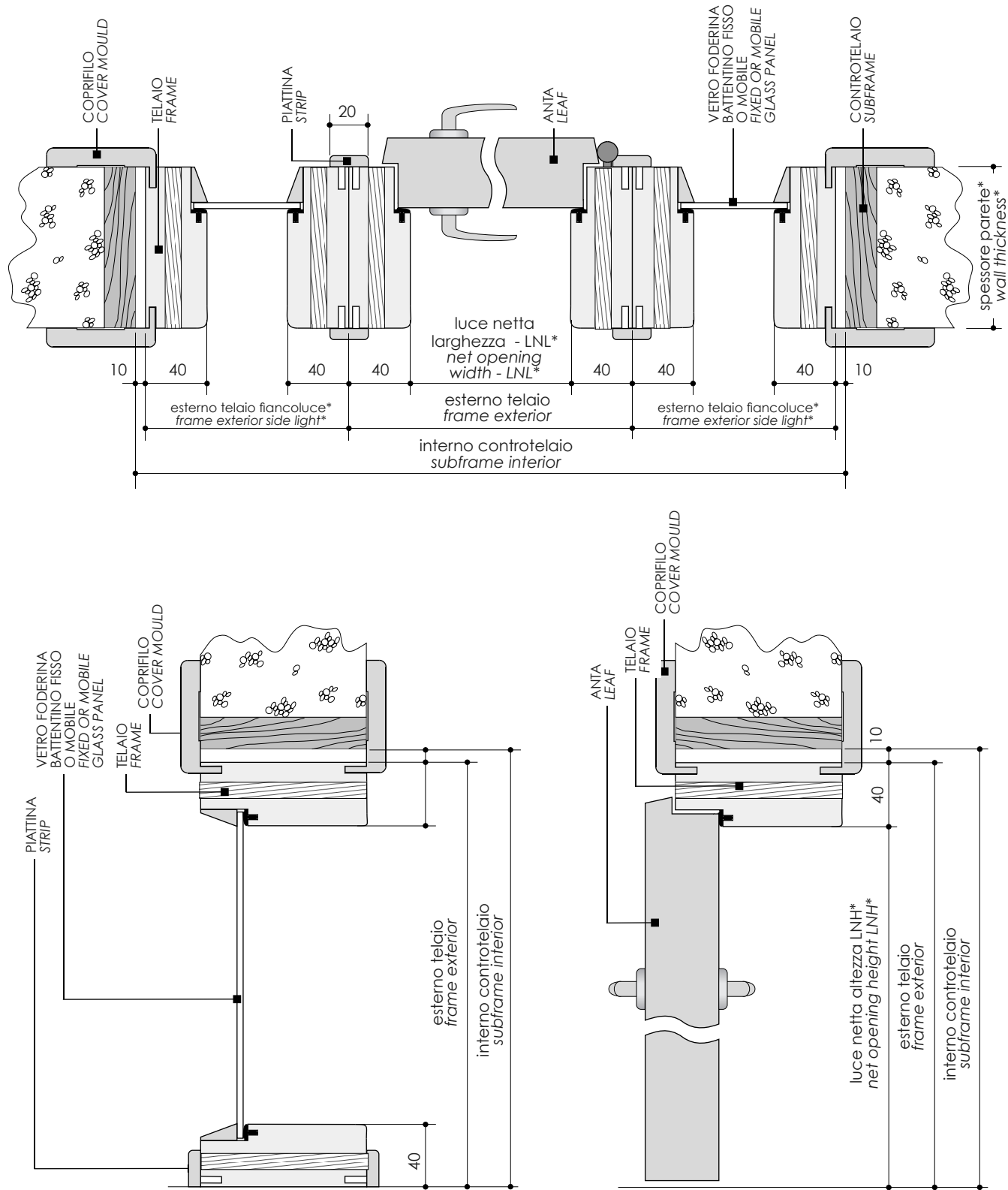
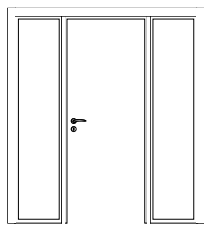

TUTTI I RIFERIMENTI CON L'ASTERISCO (*) SONO DA INDICARE NELL'ORDINE
 PER LA CONFIGURAZIONE STANDARD CORRETTA TELAIO / COPRIFILO DI OGNI FAMIGLIA CONSULTARE IL LISTINO
 ALL REFERENCES BEARING THE ASTERISCS (*) MUST BE INDICATED IN THE ORDER
 CONSULT THE PRICELIST FOR THE CORRECT STANDARD CONFIGURATION OF FRAME / COVER MOULD OF EACH FAMILY

**DETERMINAZIONE MISURE TAGLIO VETRO
 GLASS CUTTING DIMENSIONS CALCULATION**

ALTEZZA HEIGHT	LARGHEZZA WIDTH
LNH - 24	esterno telaio fiancoluce - 64 frame exterior side light - 64
2100 - 24	400 - 64

TUTTI I RIFERIMENTI CON L'ASTERISCO (*) SONO DA INDICARE NELL'ORDINE
 PER LA CONFIGURAZIONE STANDARD CORRETTA TELAIO / COPRIFILO DI OGNI FAMIGLIA CONSULTARE IL LISTINO
 ALL REFERENCES BEARING THE ASTERISCS (*) MUST BE INDICATED IN THE ORDER
 CONSULT THE PRICELIST FOR THE CORRECT STANDARD CONFIGURATION OF FRAME / COVER MOULD OF EACH FAMILY

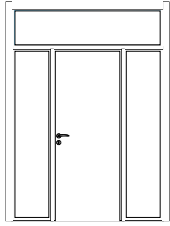
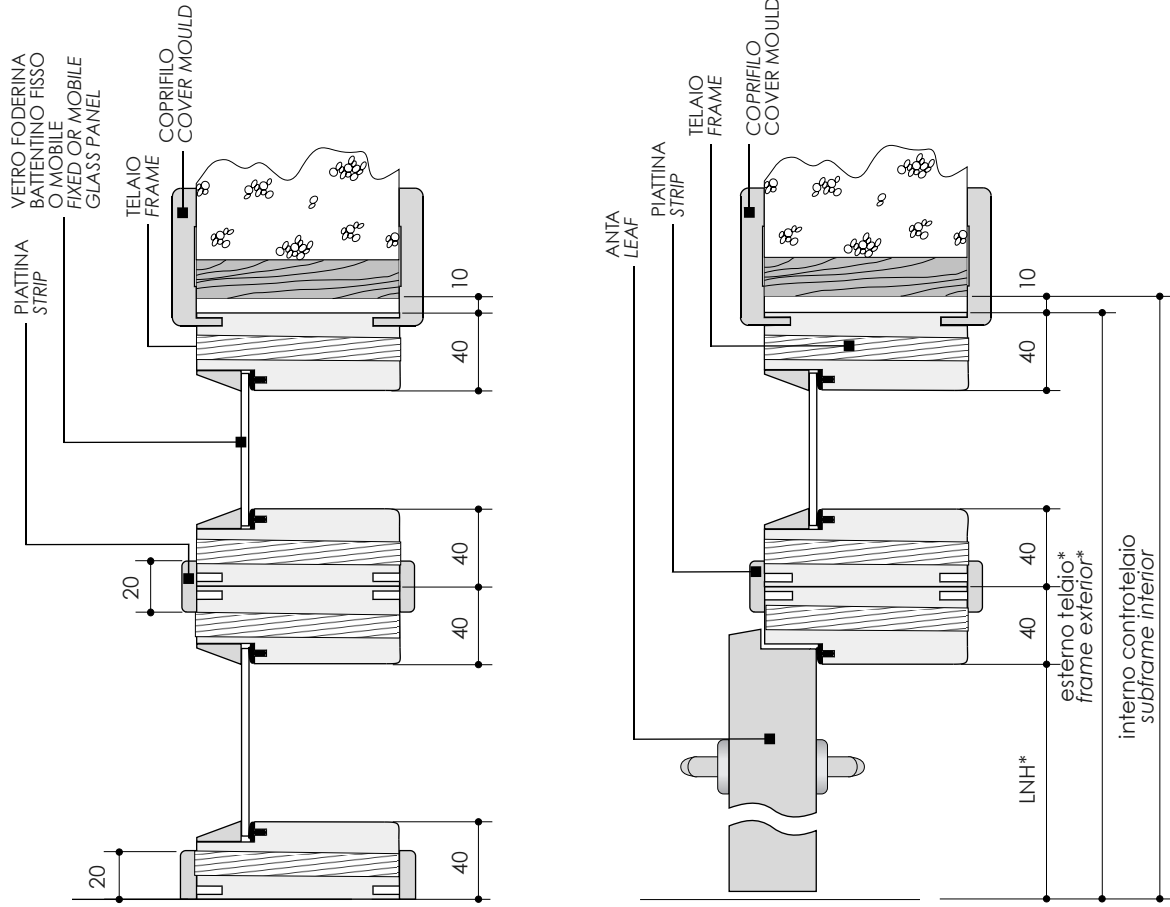
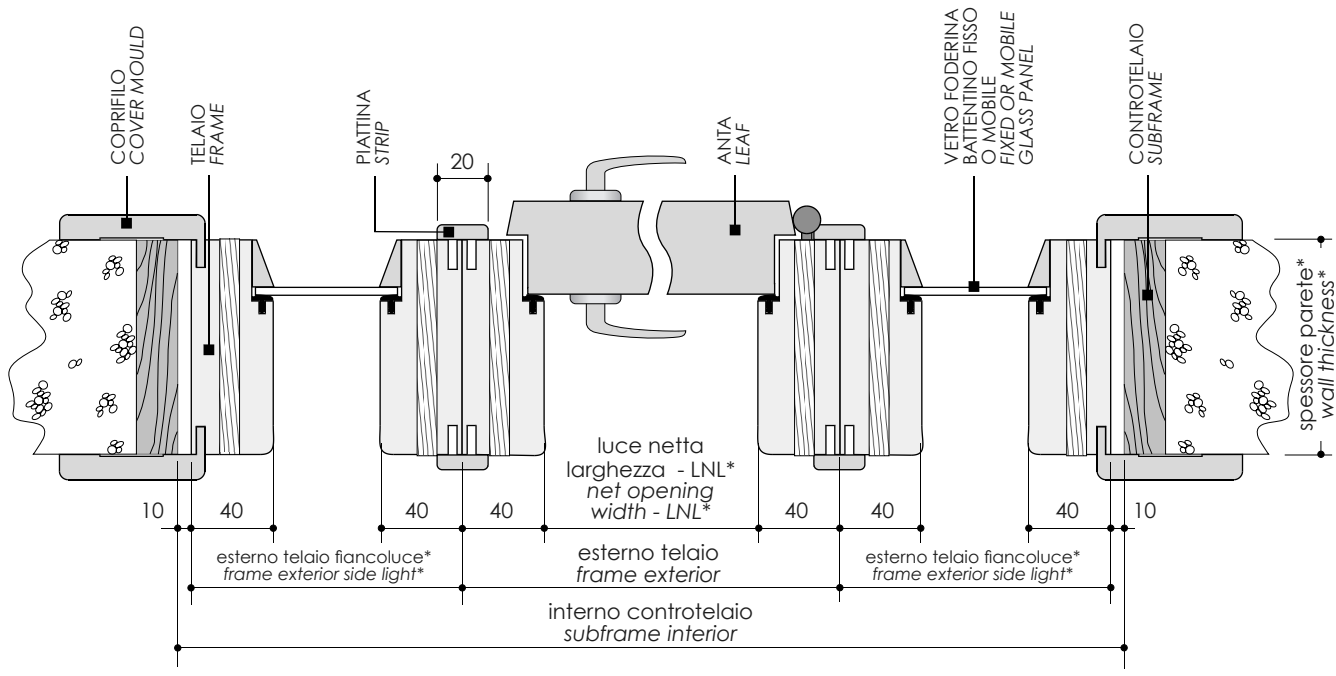

OPENING WITH OVERHEAD DOORLIGHT AND DOUBLE SIDELIGHT
 APERTURA CON SOPRALUCE E DOPPIO FIANCOLUCE
 BELLINI - DANIELI - FORTE - JUVARRA - LUCCHINI - SAVINI



www.dierre.com

PORTEDI SPA - Società per Azioni con Unico Socio
Società sottoposta ad attività di direzione e coordinamento da parte della DIERRE SPA
C.SO SOMMELIER 23 10128 TORINO - TEL 011.9324200 - FAX 0141.686910